

组成优质压接的部分

- 电线
- 端子
- 工具
- 文件
- 合格的受训人员

组成优质压接的部分

- 电线
- 端子
- 工具
- 文件
- 合格的受训人员

电线的组成

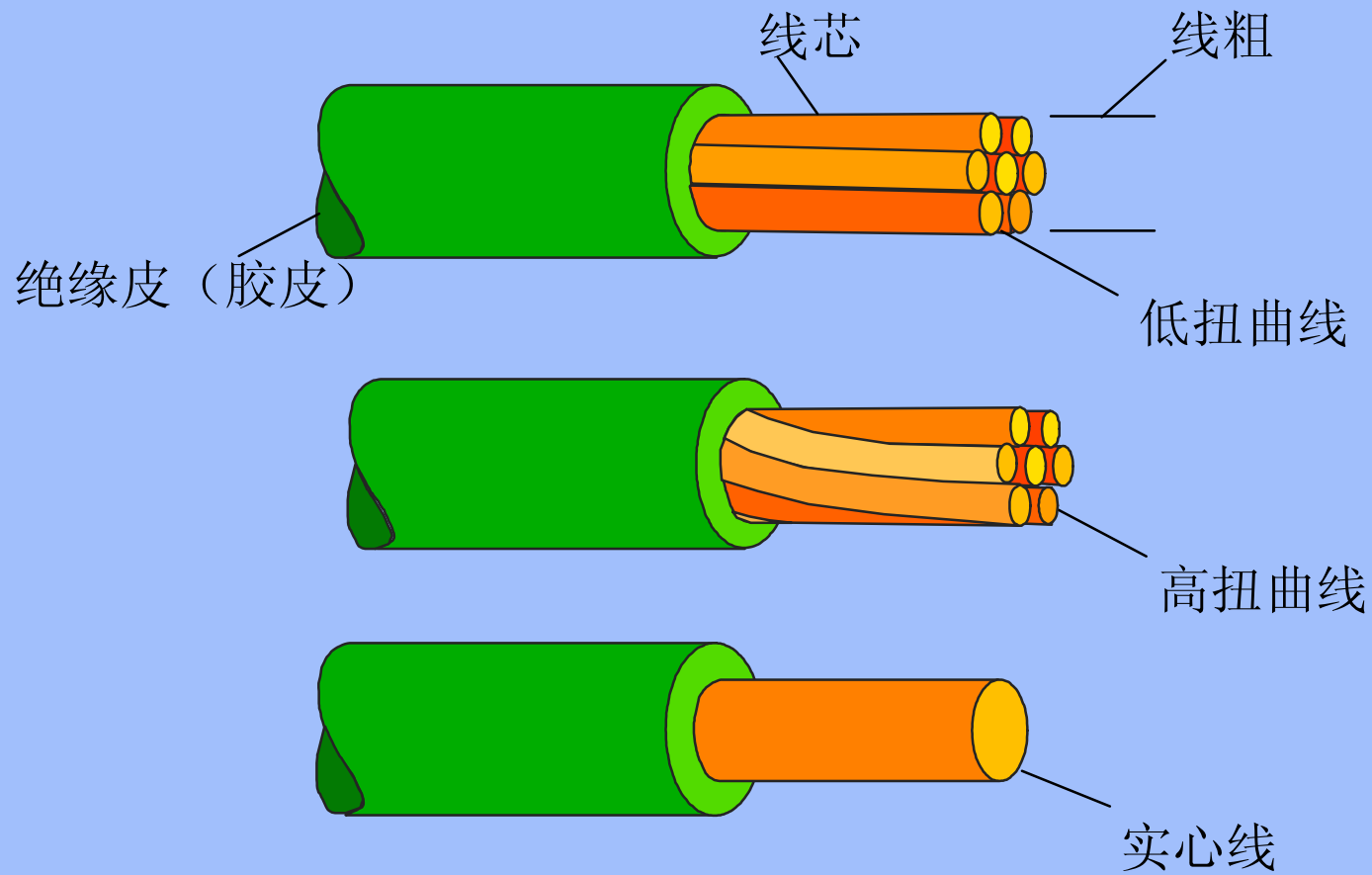

电线的尺寸

24AWG

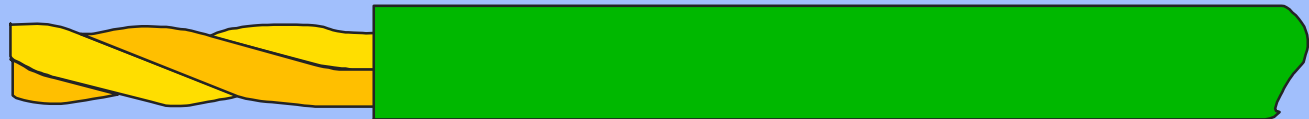

18AWG



12AWG

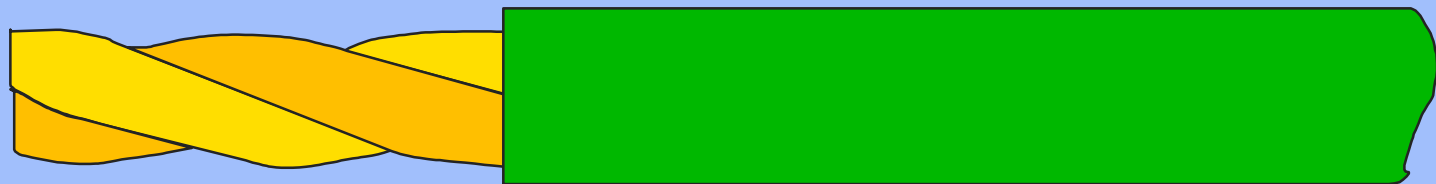

什么是CMA？

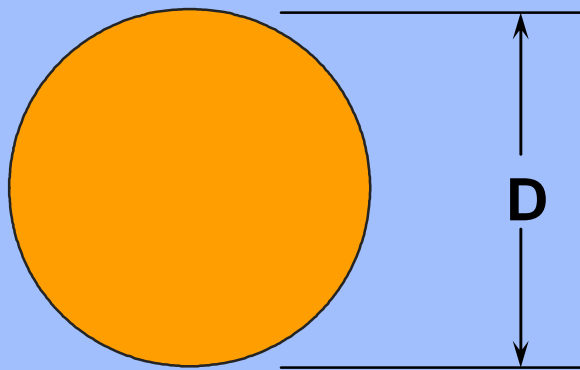

$$CMA = D^2$$

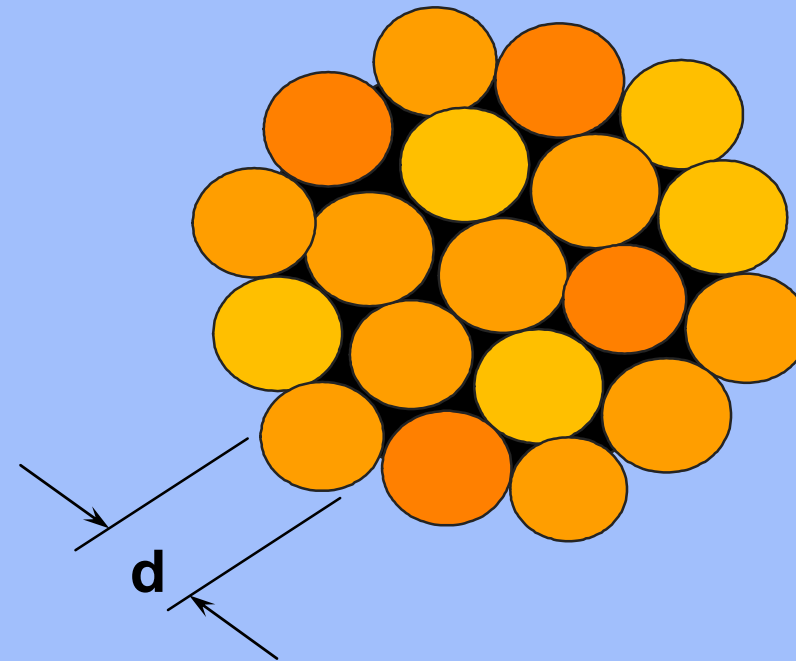

$$CMA = d^2 \times N$$

N = 线心的数量

CMA 图表

CMA	普通导线尺寸		标准		
	AWG	MM ²	Number	直径	
				Inch	MM
1504	18.5	0.75	30	.0071	0.180
1600	18	0.8	16	.0100	0.254
1624	18	0.8	1	.0403	1.024
2537	16	1.25	16	.0125	0.320
2581	16	1.3	1	.0508	1.290
2800	16	1.4	7	.0200	0.508
3260	15	1.6	1	.0571	1.450
4123	14	2	26	.0126	0.320
4167	14	2	105	.0063	0.160
4234	14	2	84	.0071	0.180

绝缘皮厚度变化

18AWG

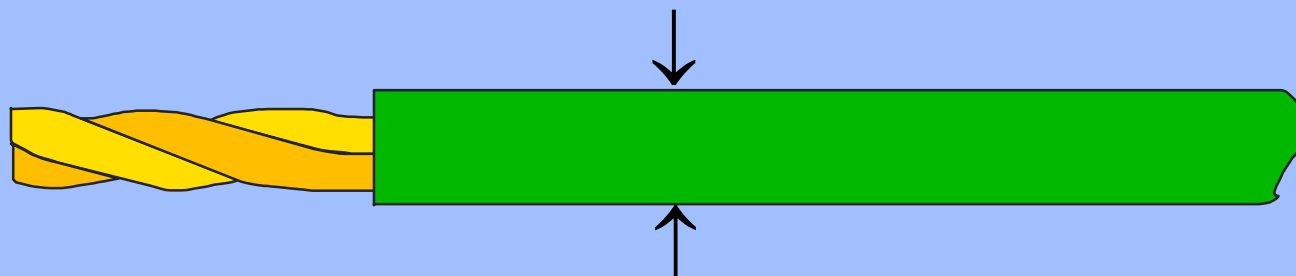

18AWG

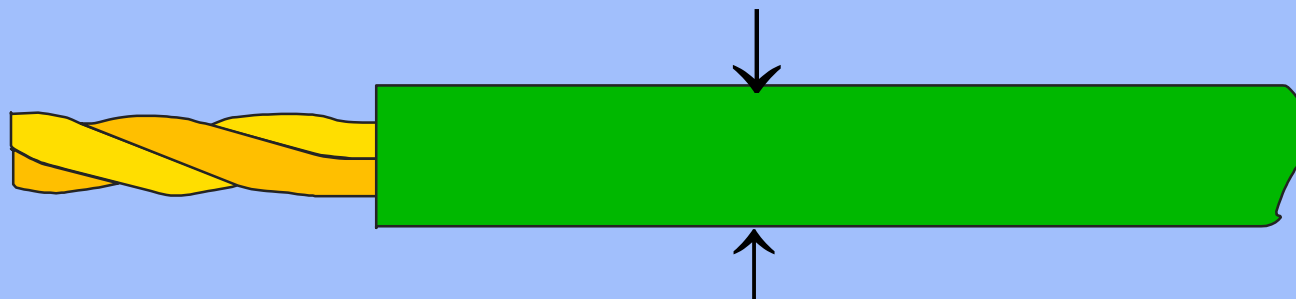

18AWG

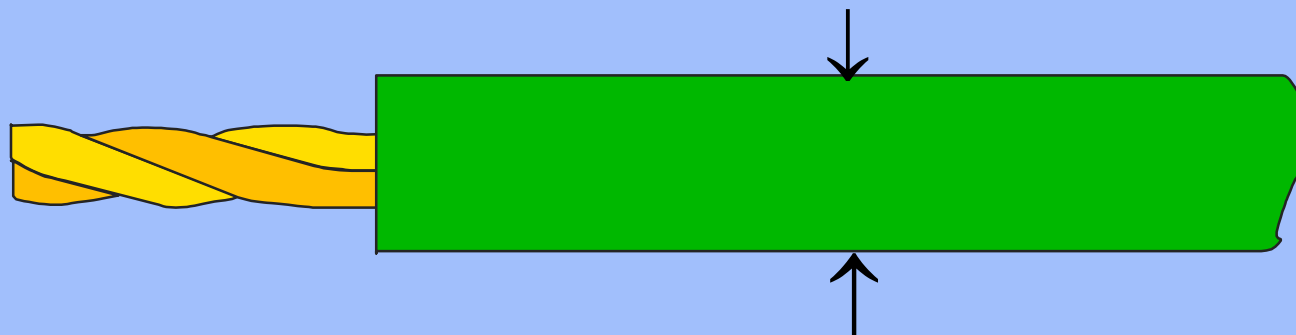

好的开线

绝缘皮切面均匀

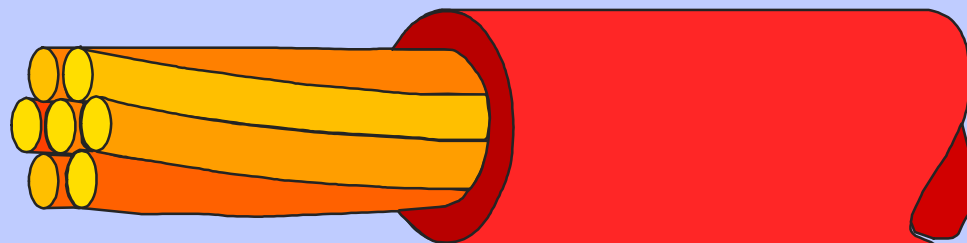

没有使线芯受伤及折断

不良的开线

使线心受伤

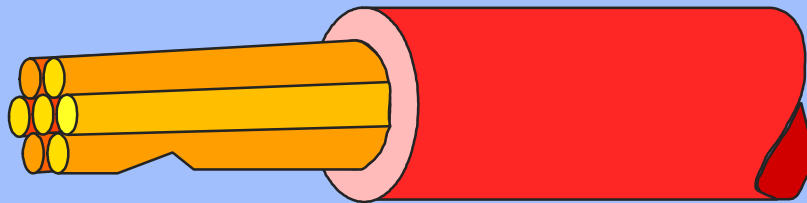

不均匀切角

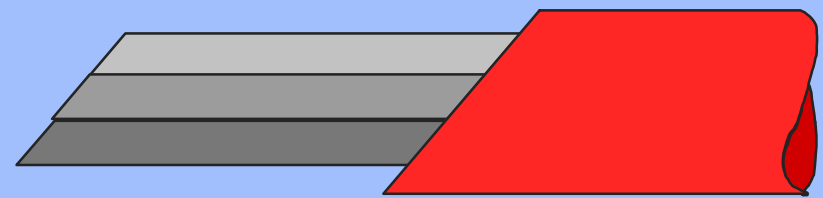

切断线心

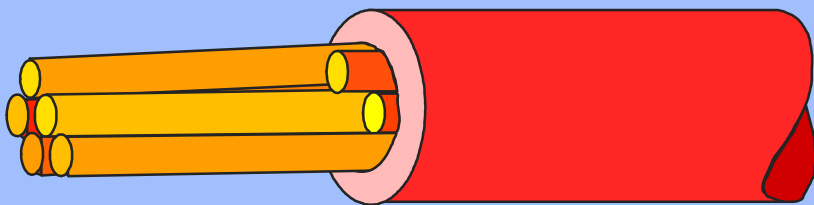

拉长胶皮

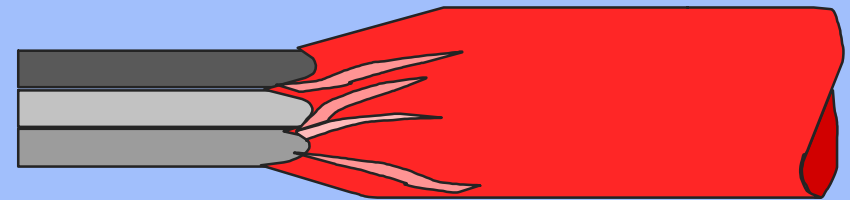

不良的开线会减弱导电性

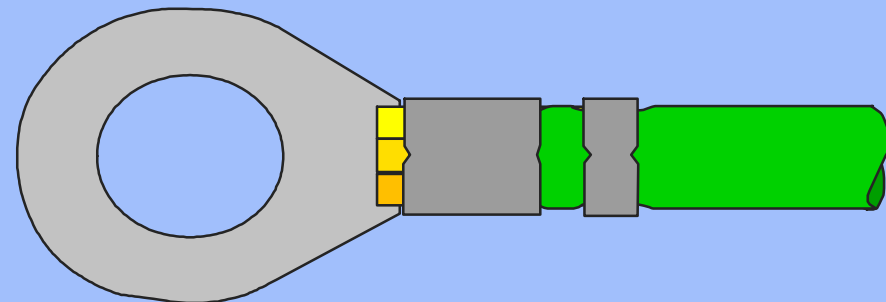
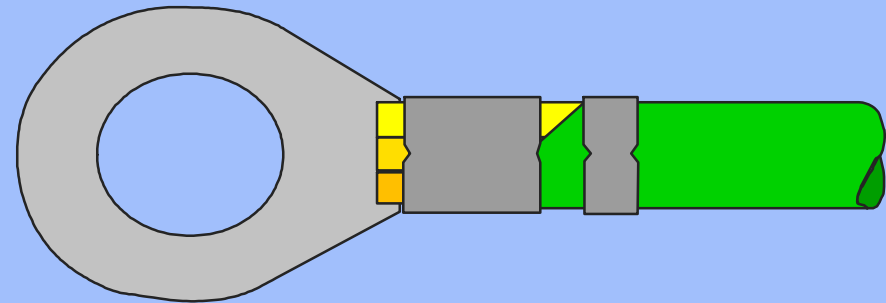
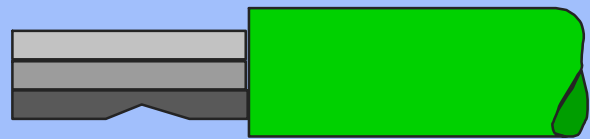
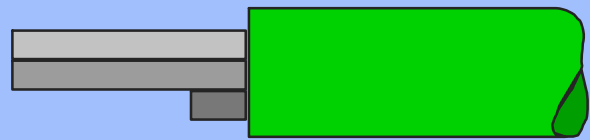

使线芯受伤或折断会降低机械强度和电气强度和电气性能

开线出现斜面将会减弱导电性能

组成优质压接的部分

- 电线
- 端子
- 工具
- 文件
- 合格的受训人员

端子的种类

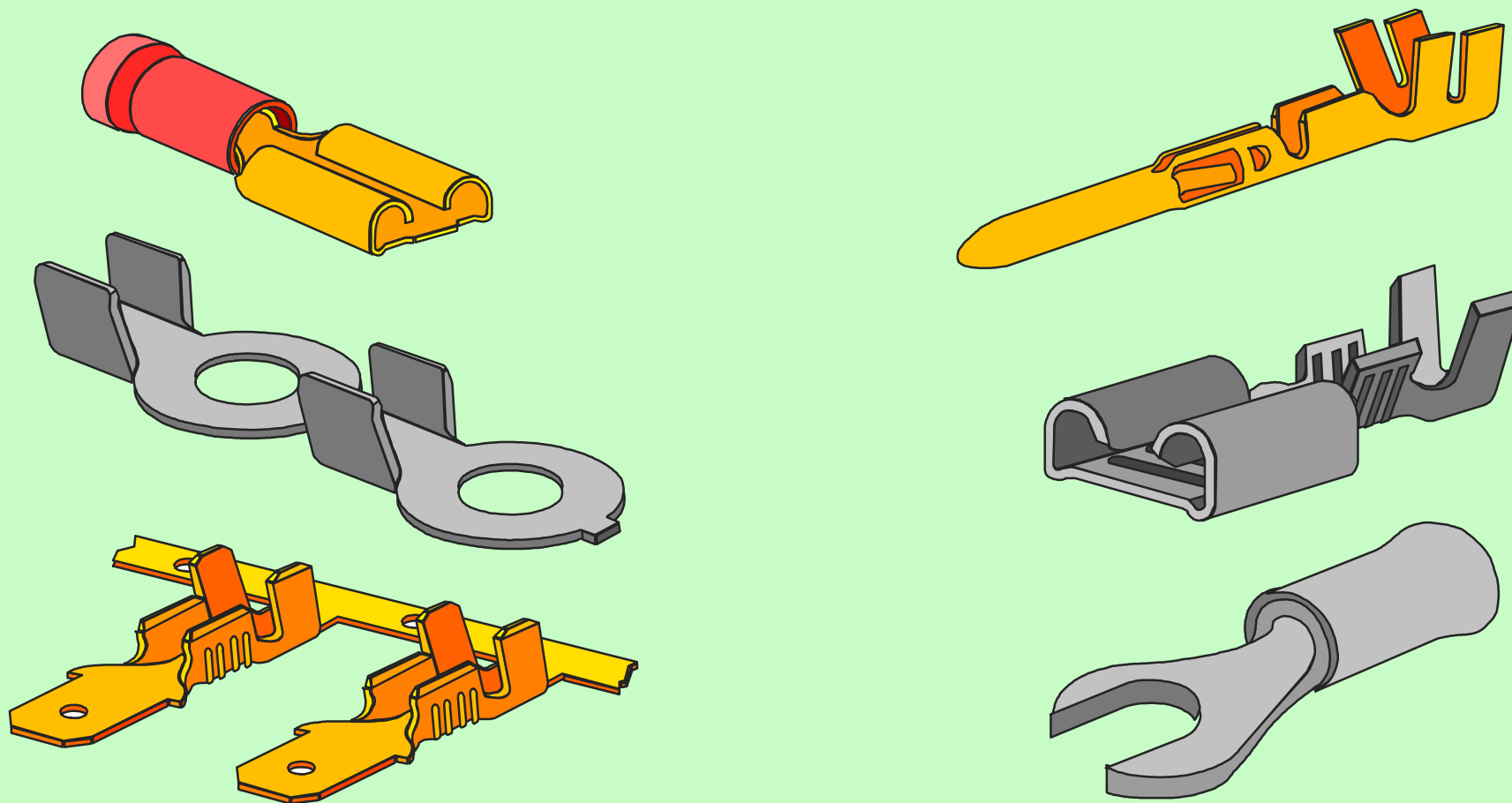

端子

闭筒式插孔端子

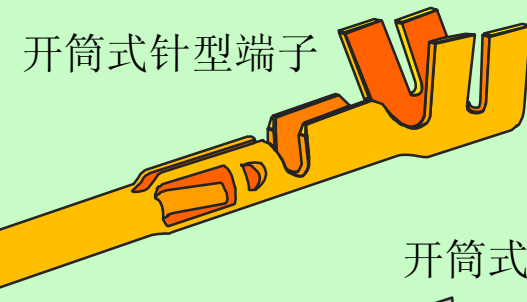
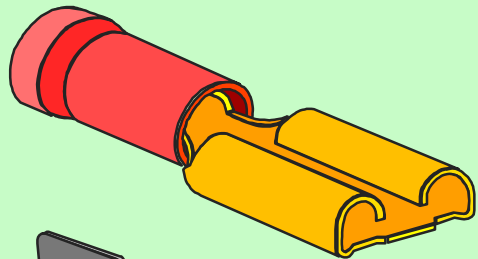

开筒式针型端子

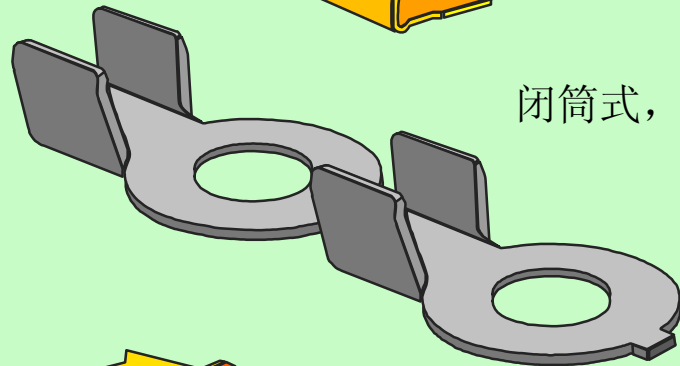

闭筒式，后送料环形端子

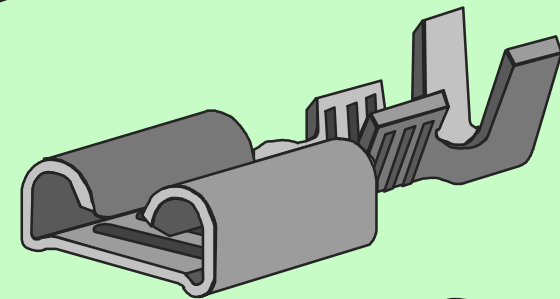

开筒式插孔端子

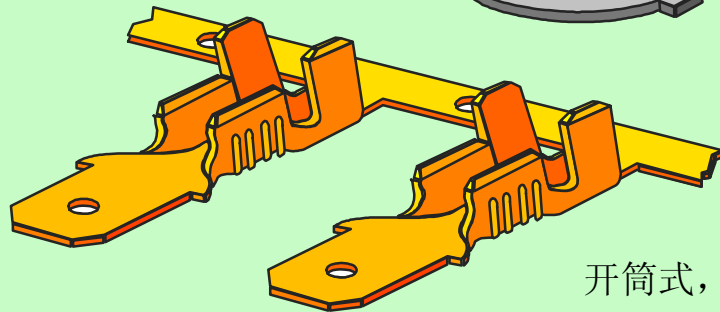

开筒式，侧边送料接片端子

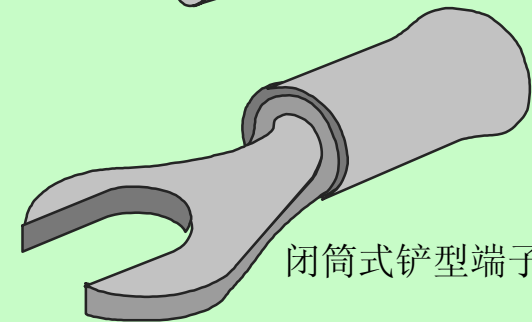

闭筒式铲型端子

开筒式端子的组成

线芯包筒

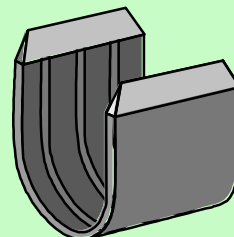

线芯包筒和连接端

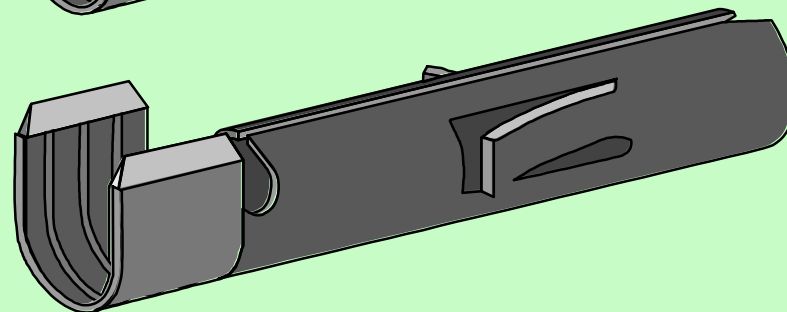

线芯包筒和连接片
以及胶皮包筒

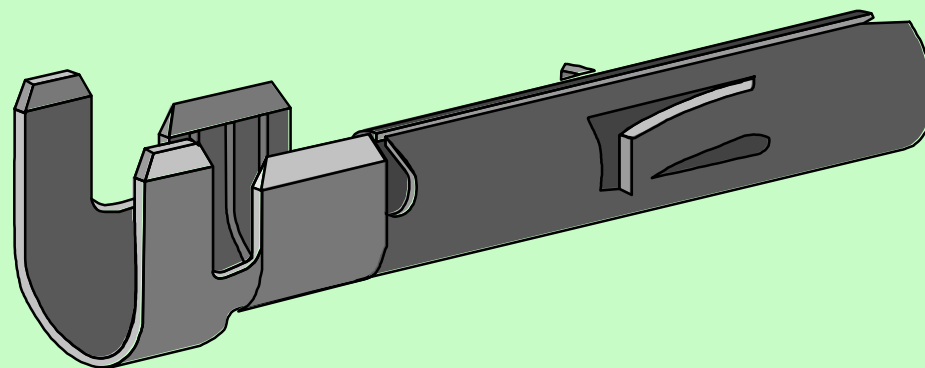

闭筒端子的组成

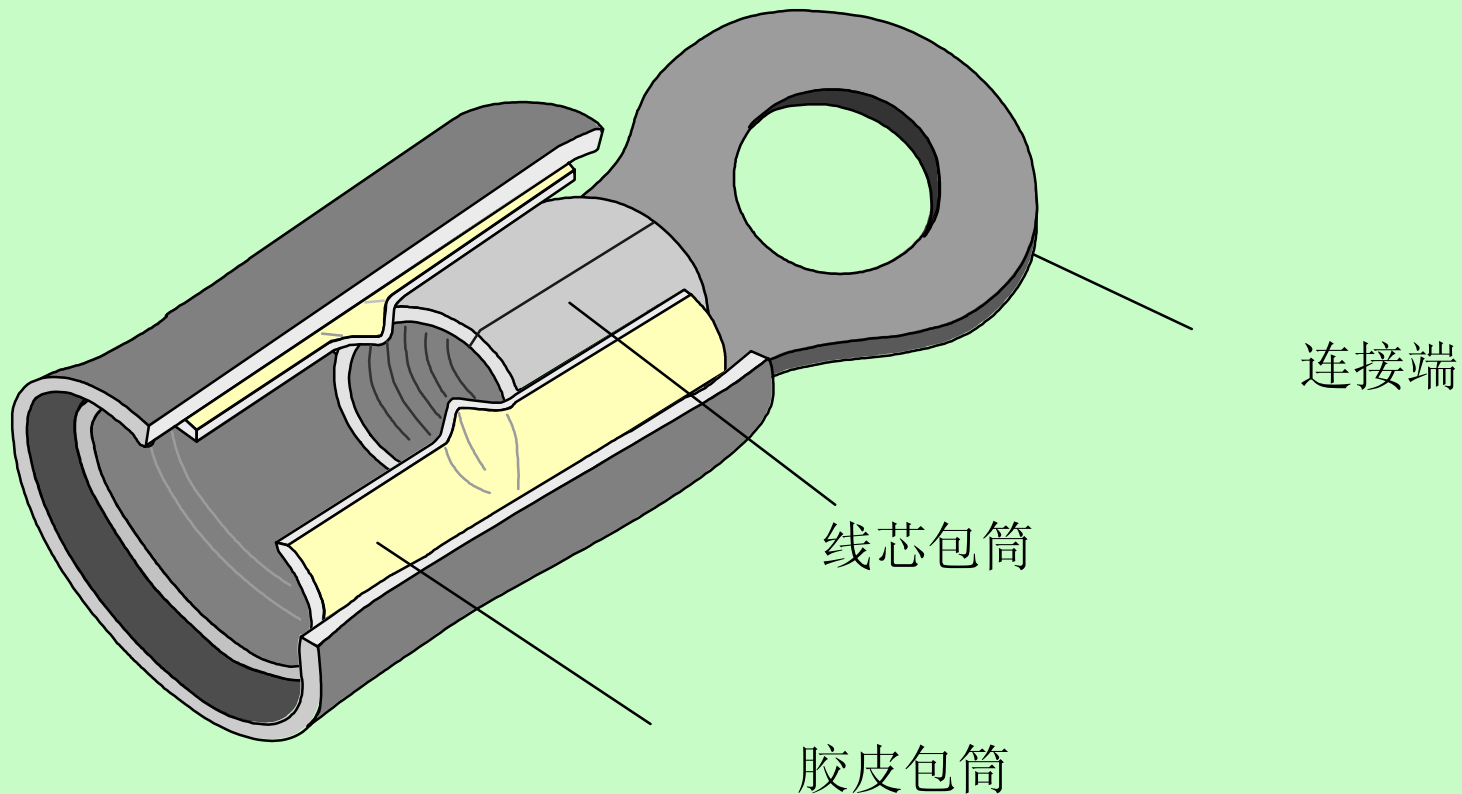

胶皮包筒的优点

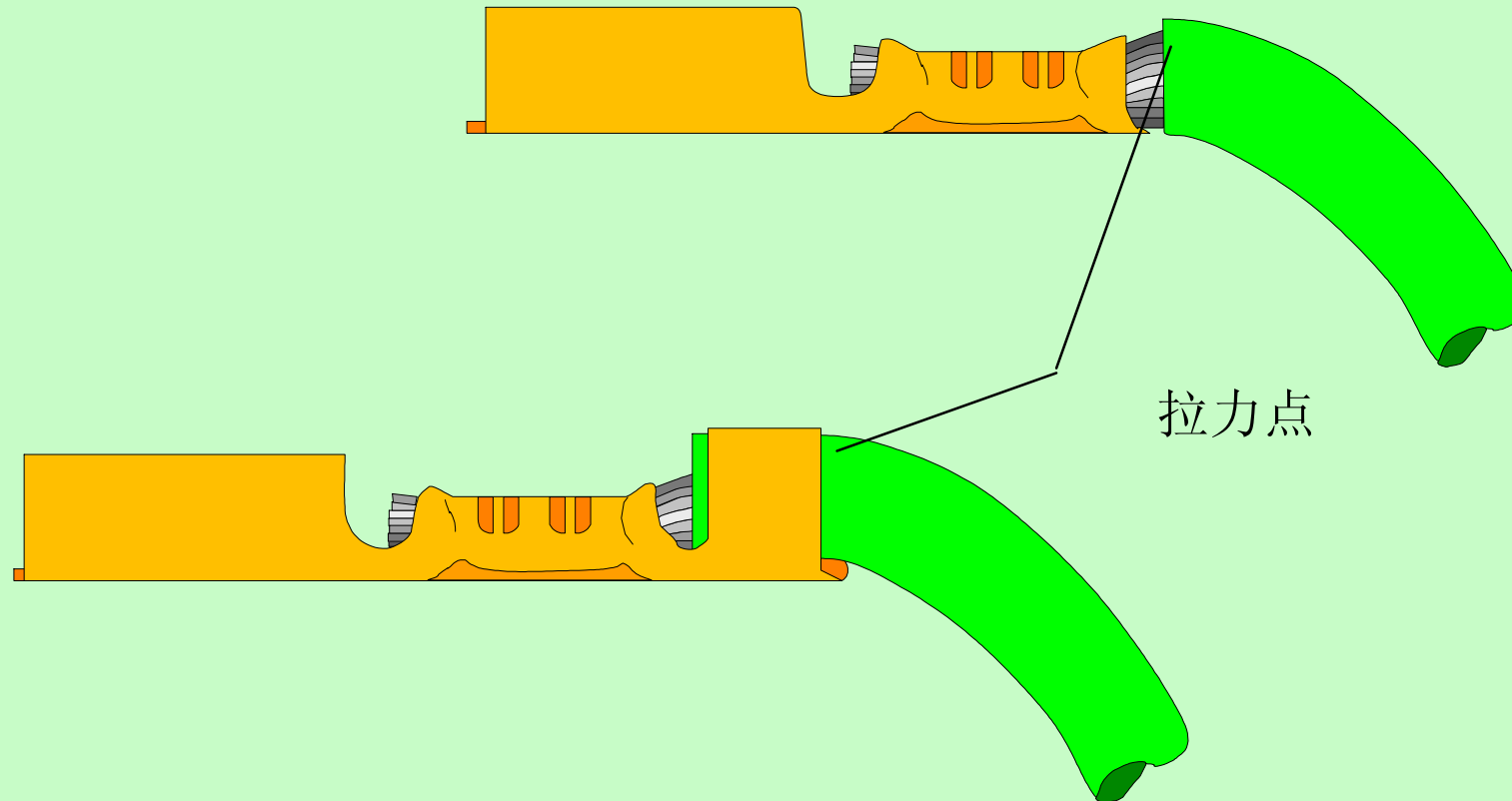

机械强度和导电性能

线心包筒和胶皮包筒的使用(开筒式)

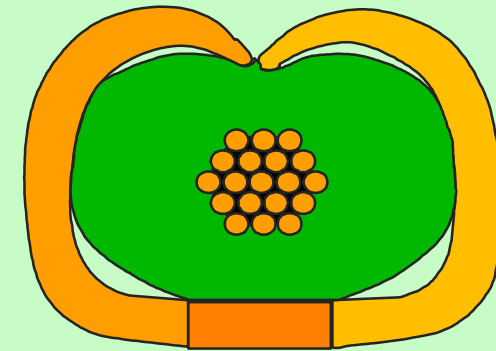
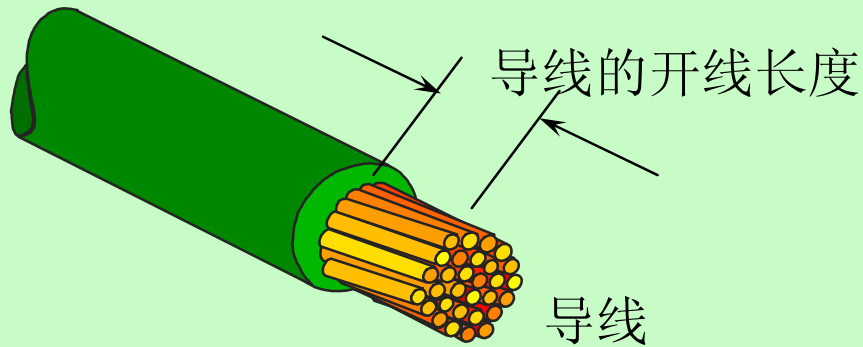

胶皮压接

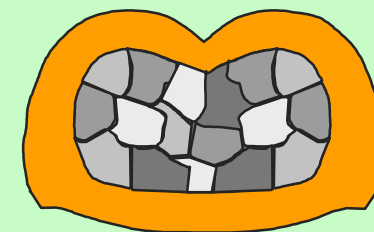
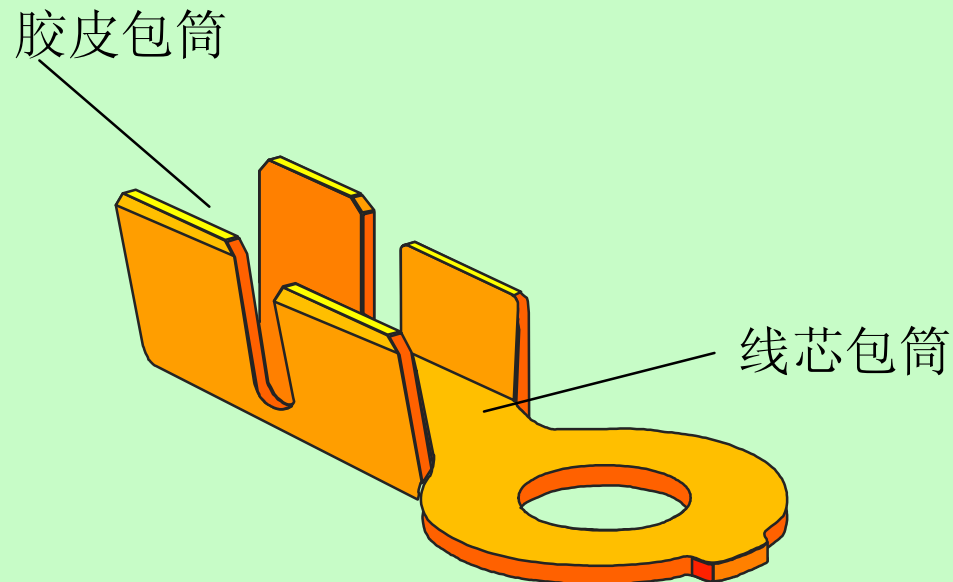

线芯压接

线心包筒和胶皮包筒的使用(闭筒式)

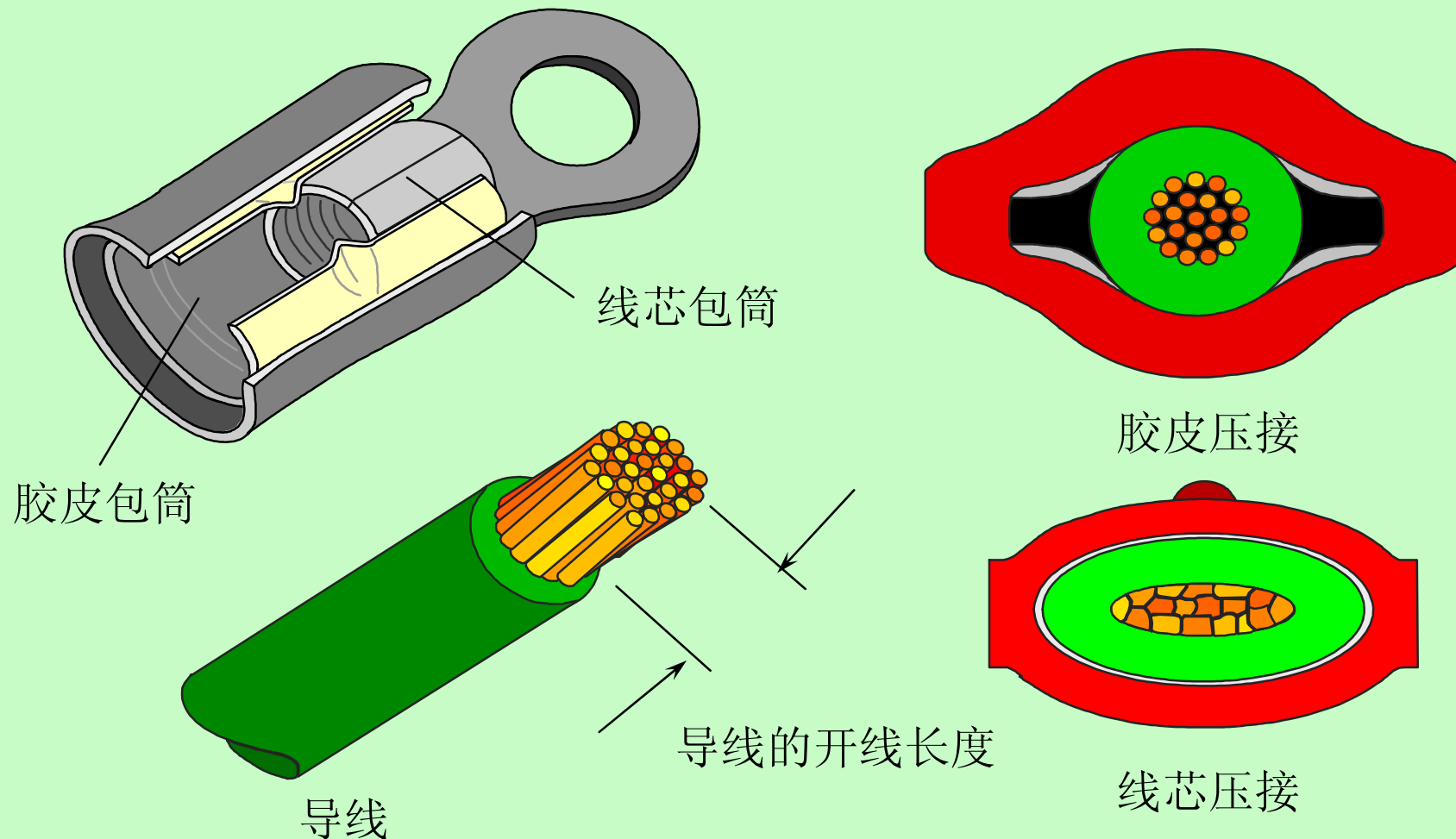

面积减少

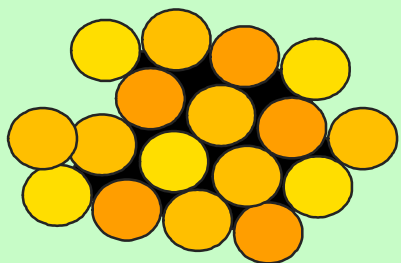

导线 =
4100 CMA

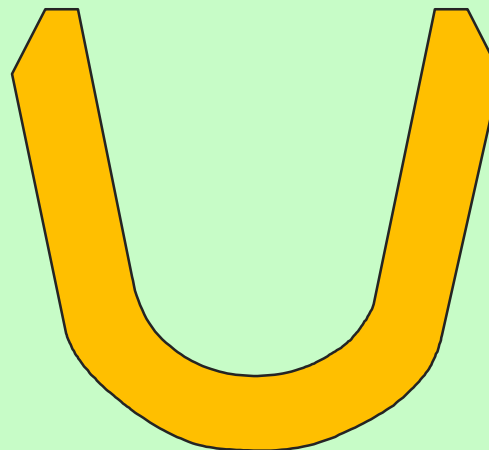

线芯包筒 =
6900 CMA

总共 =
11,000 CMA

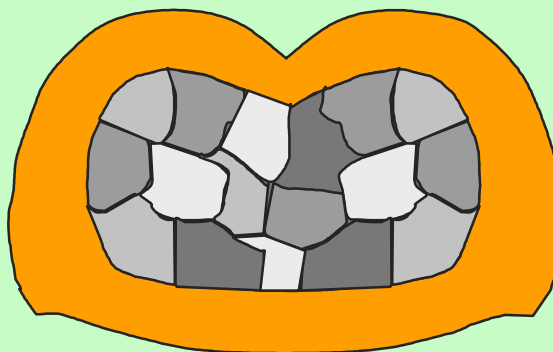

压接完成
8800 CMA

机械强度

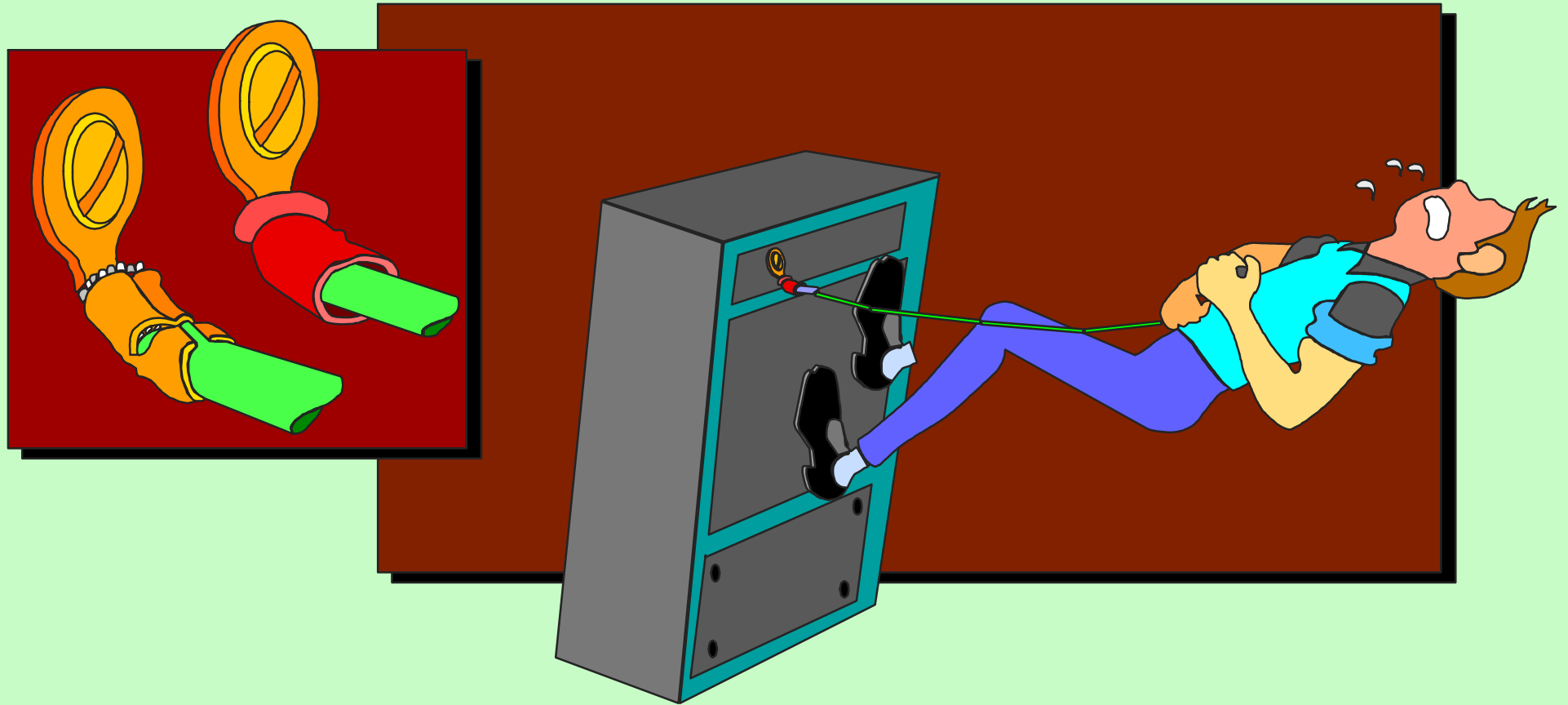

机械强度

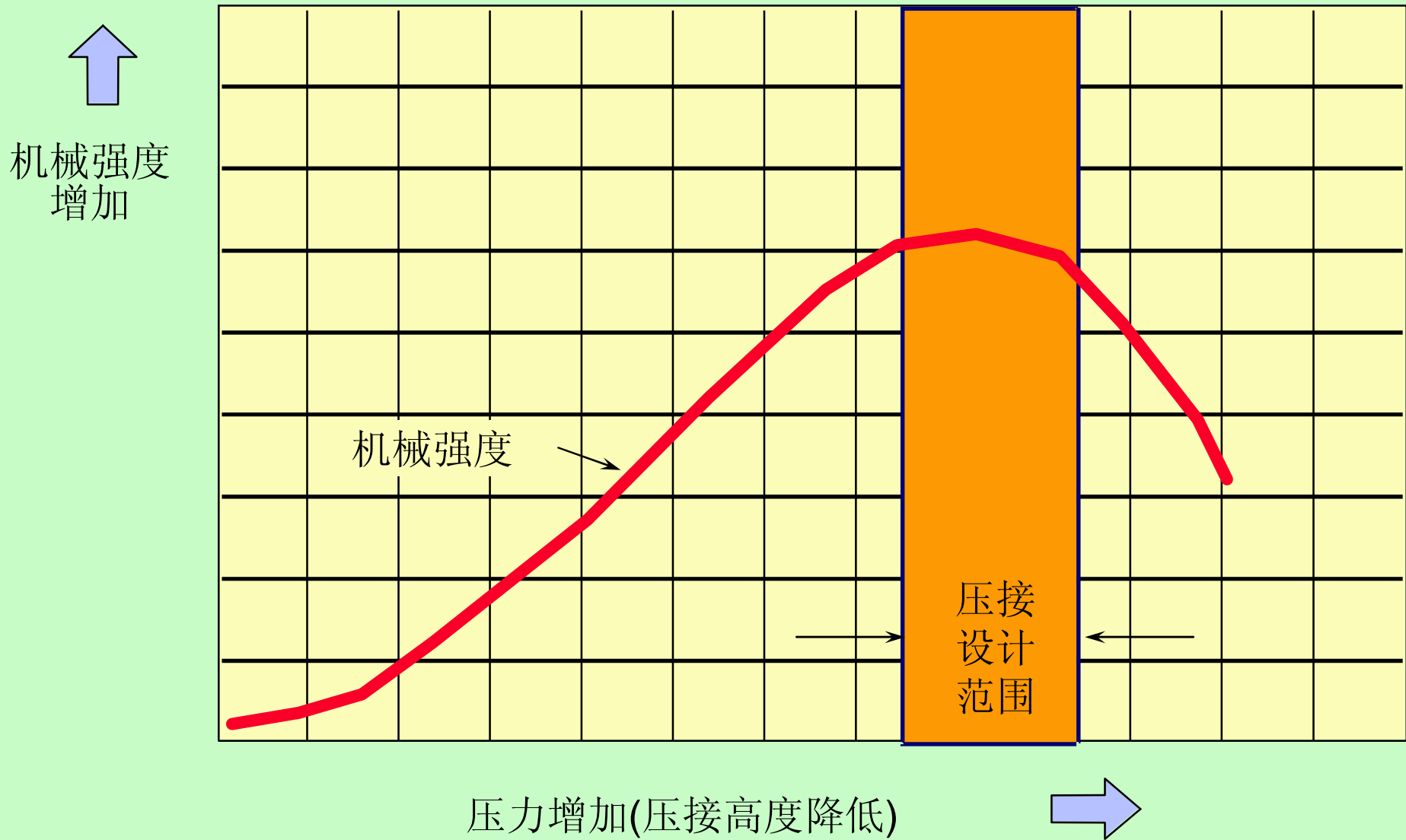

导电性能

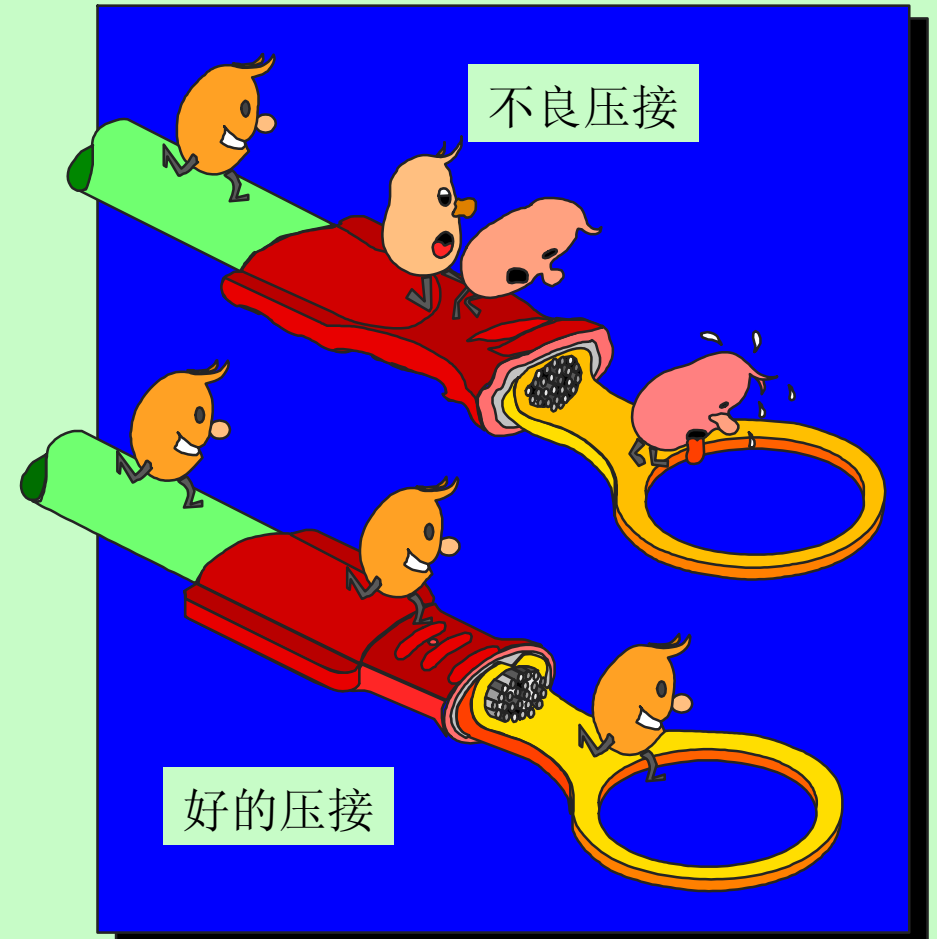
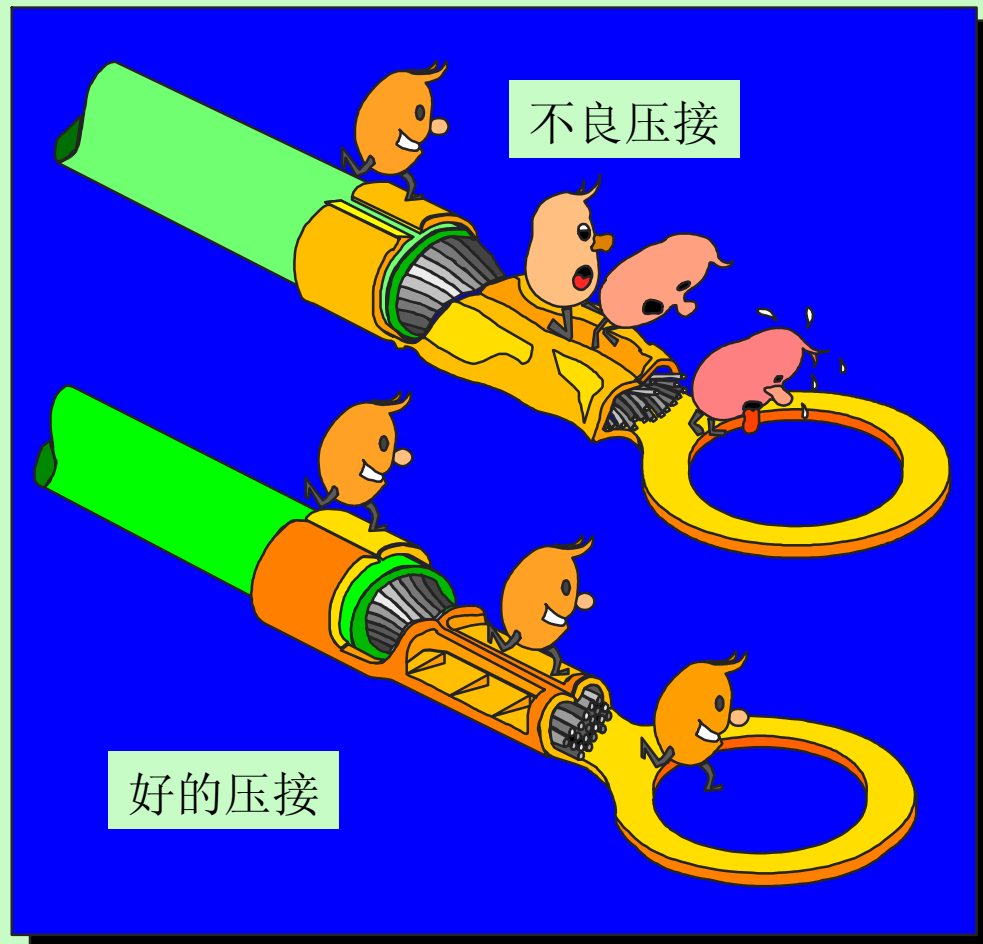

导电性能

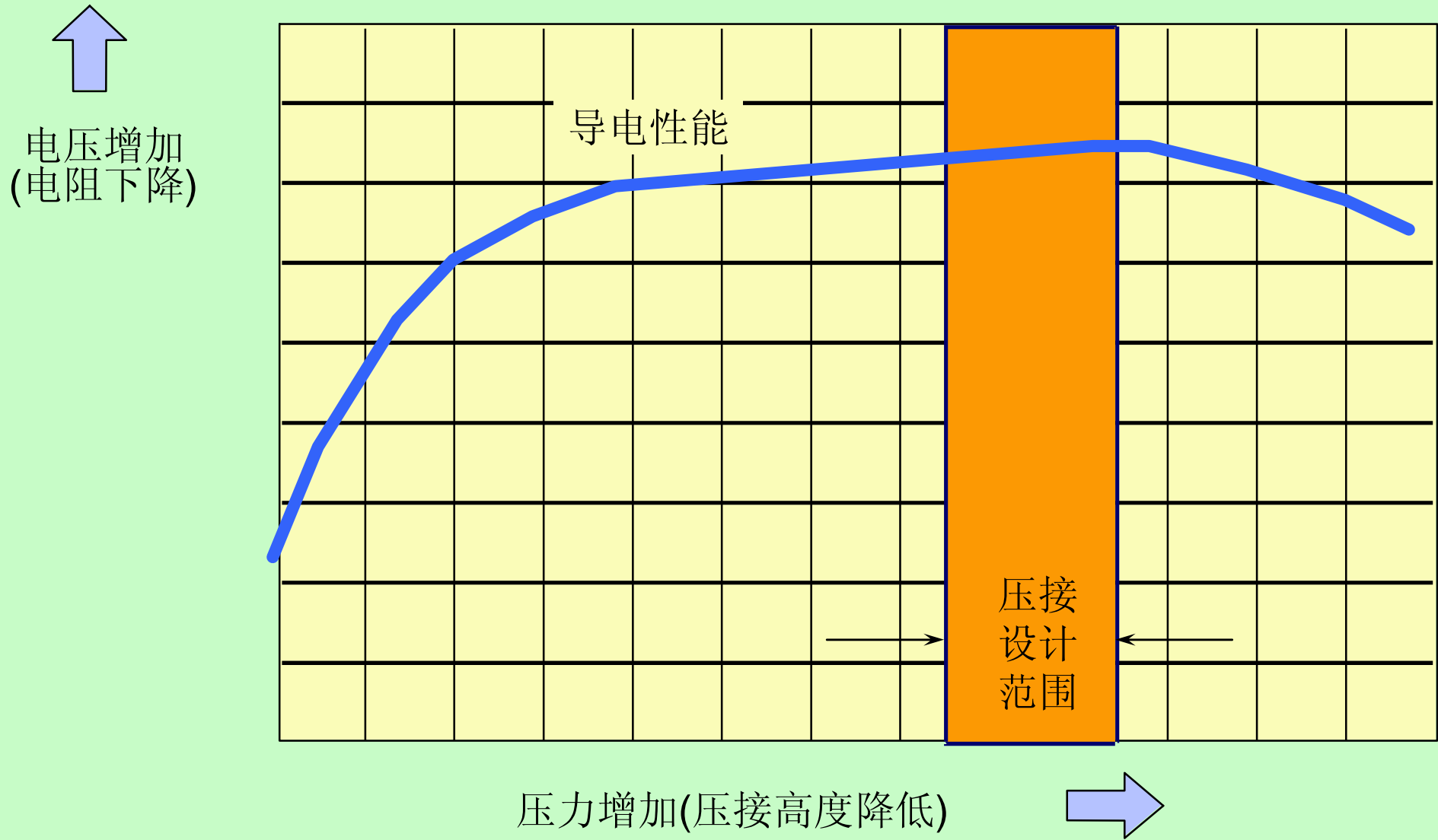

压接设计参数

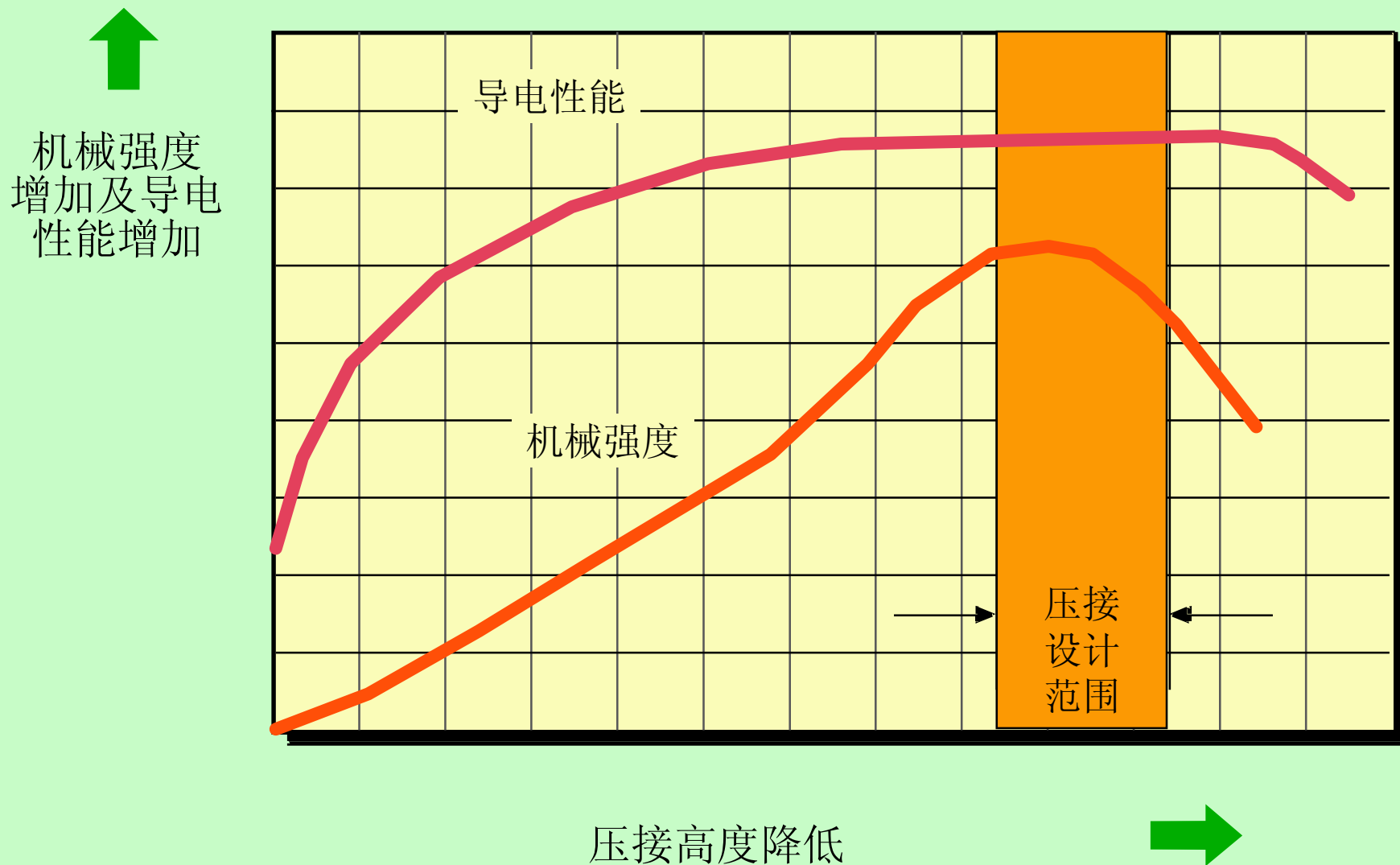

组成优质压接的部分

- 电线
- 端子
- 工具
- 文件
- 合格的受训人员

应用工具

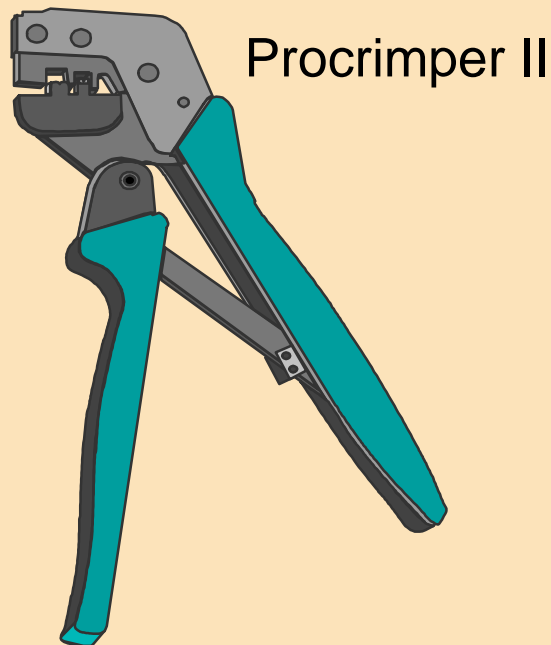

Dyna-液压设备

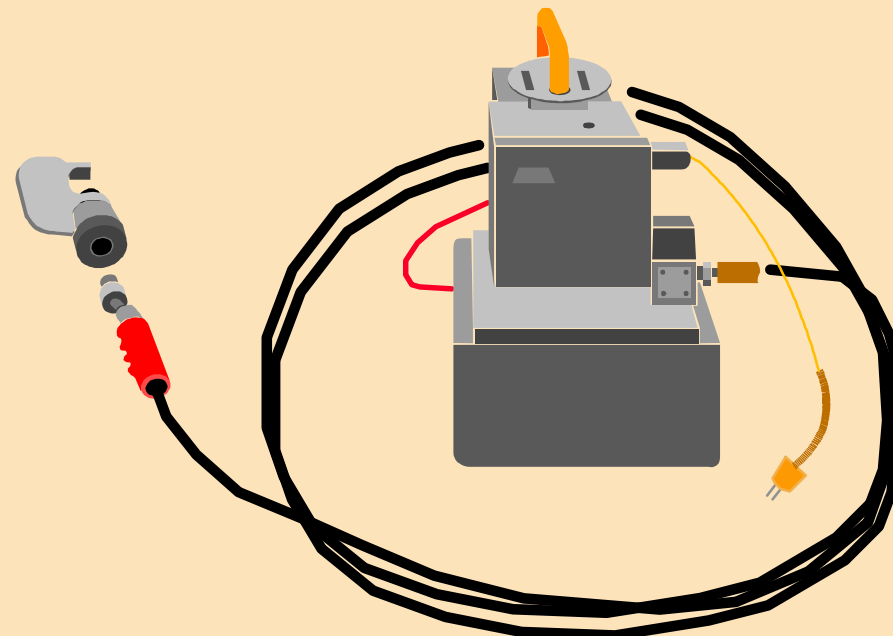

626 气动工具

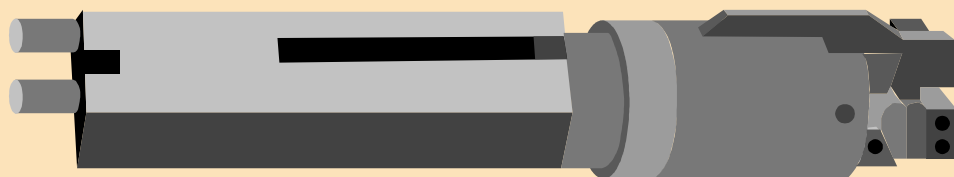

应用工具

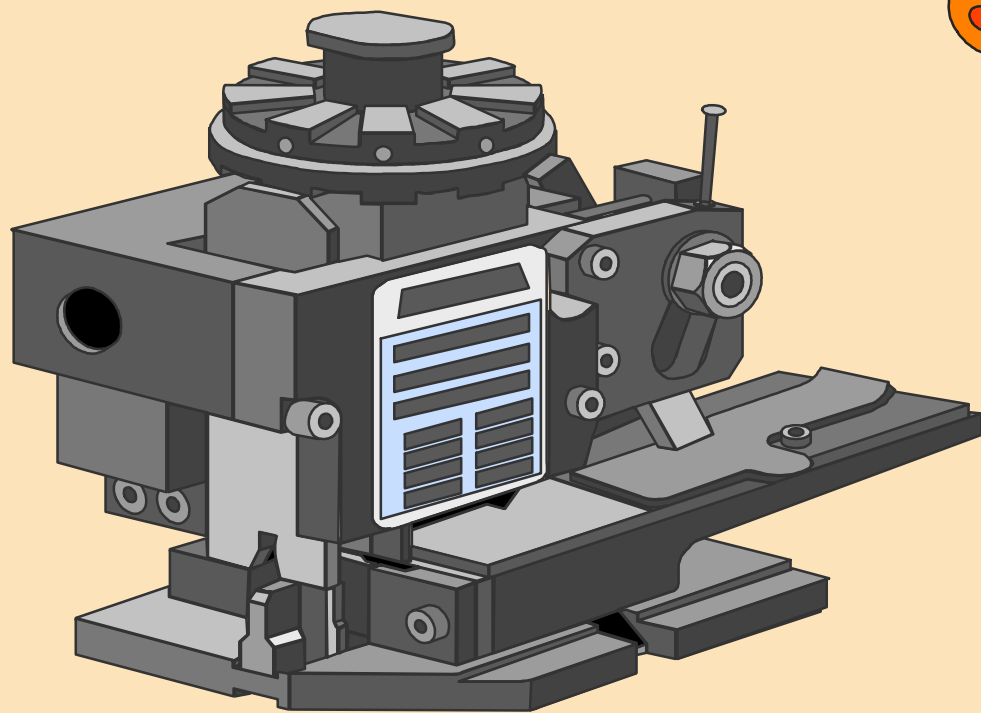

HD MINI

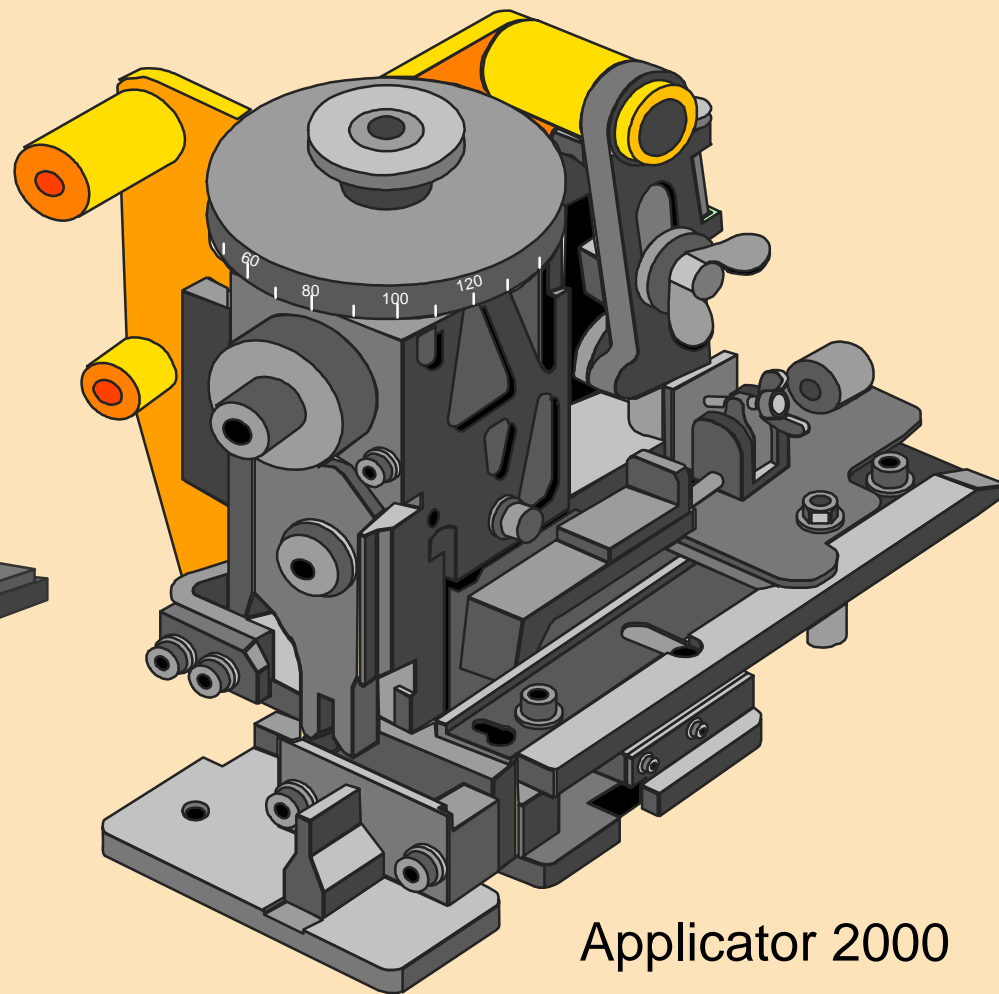

Applicator 2000

模具

半自动压接机

K型压接机

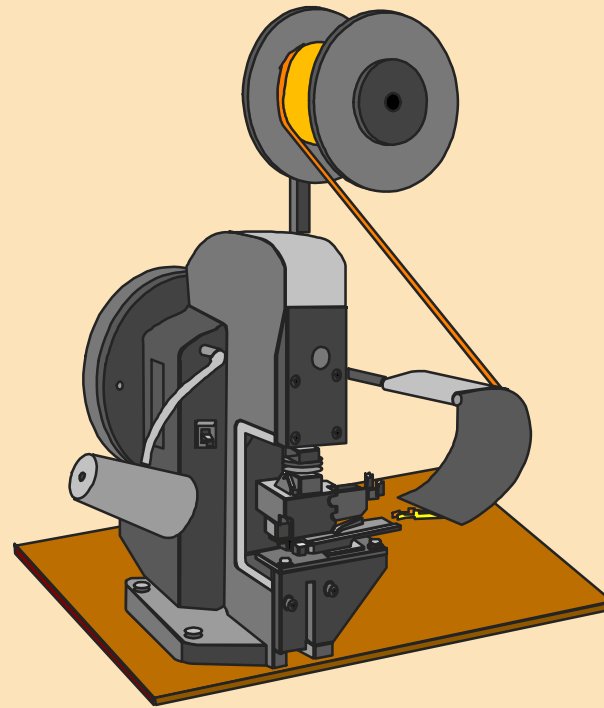

M型压接机

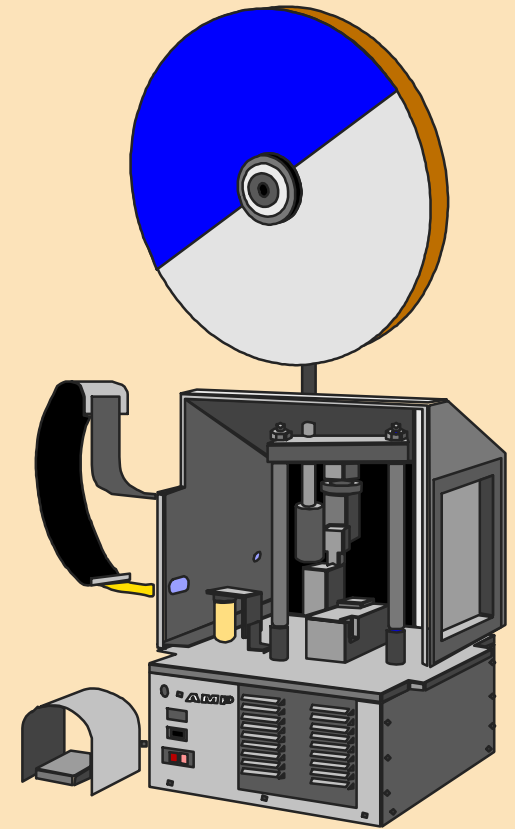

G型压接机

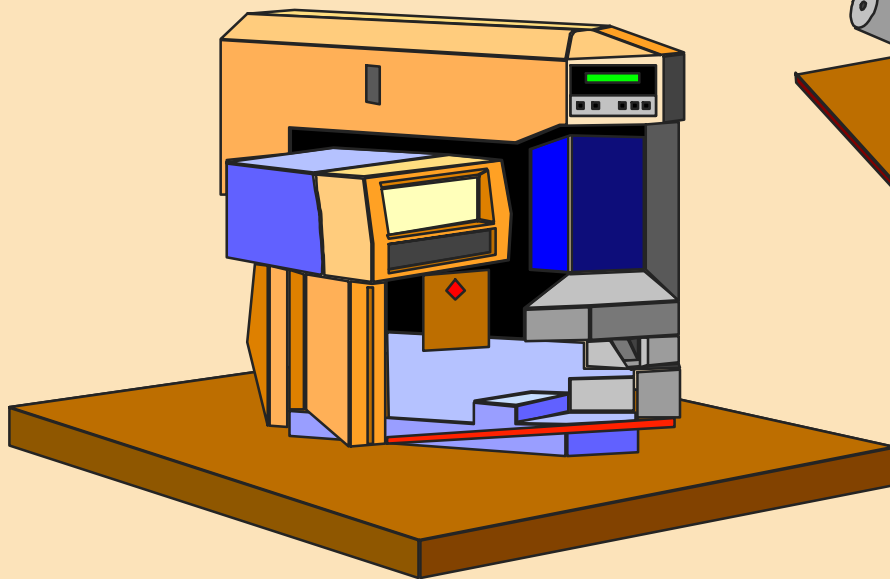

台式压接机

半自动压接机

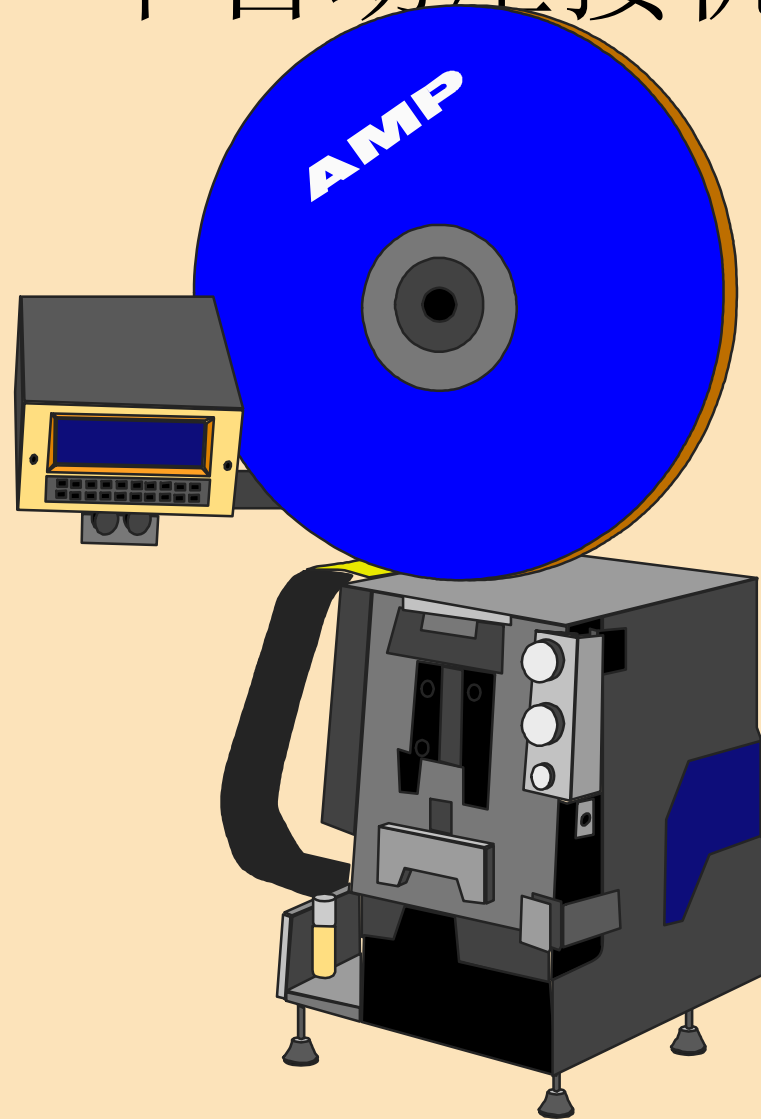

开线皮压接机

组成优质压接的部分

- 电线
- 端子
- 工具
- 文件
- 合格的受训人员

组成优质压接的部分

- 电线
- 端子
- 工具
- 文件
- 合格的受训人员

准确地测量压接的端子

调整线芯压接和胶皮压接

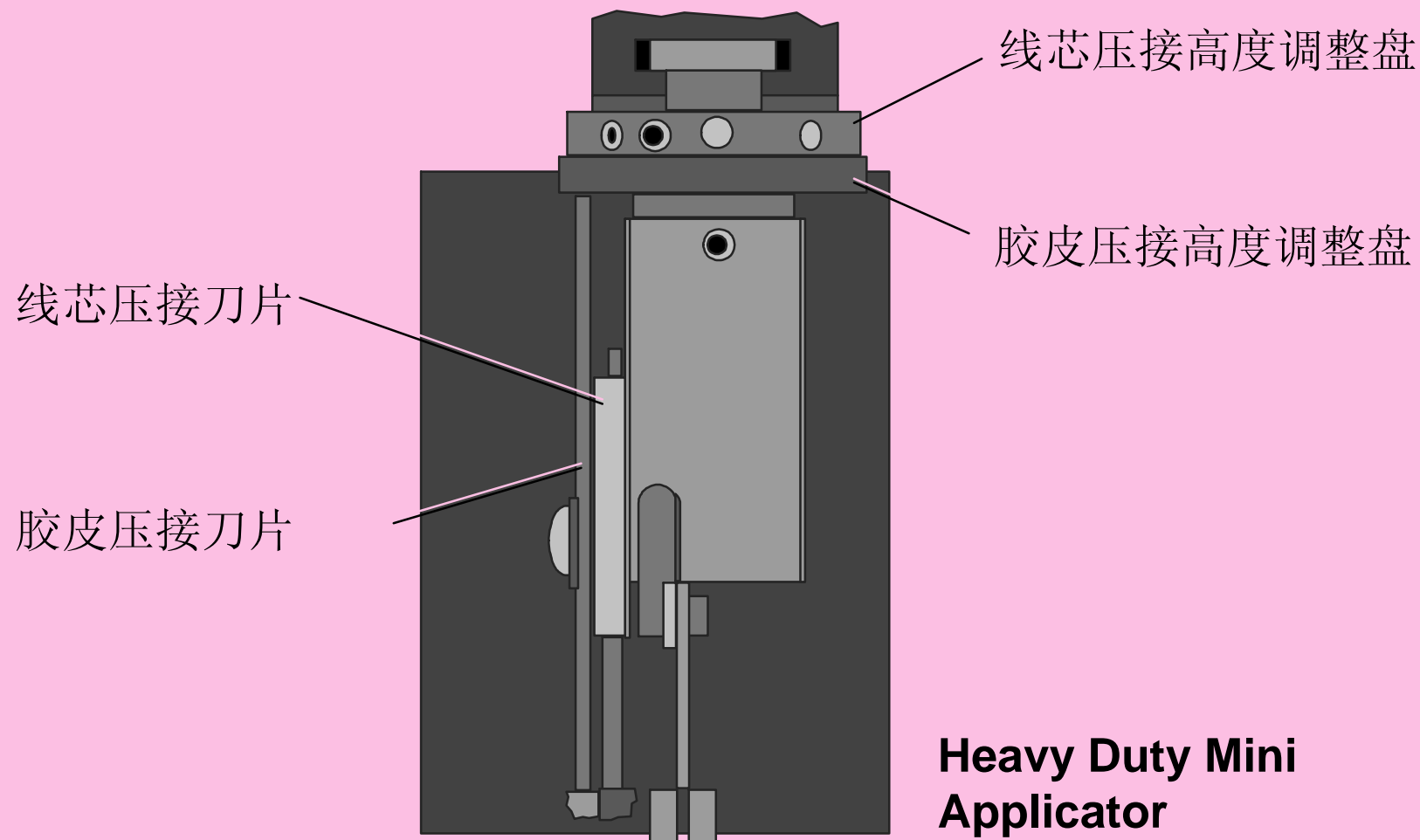

压接高度的测量

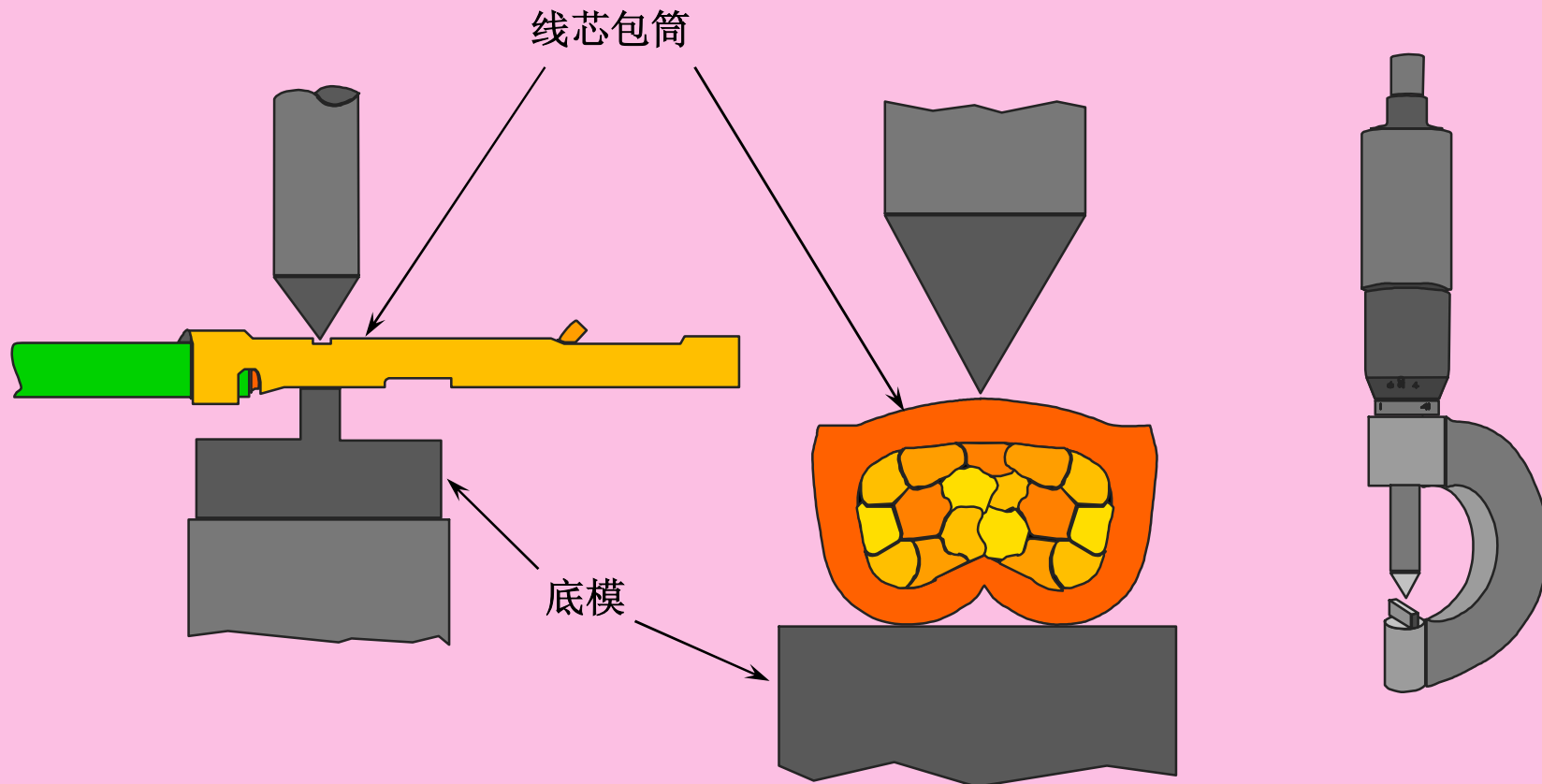

拉力测试

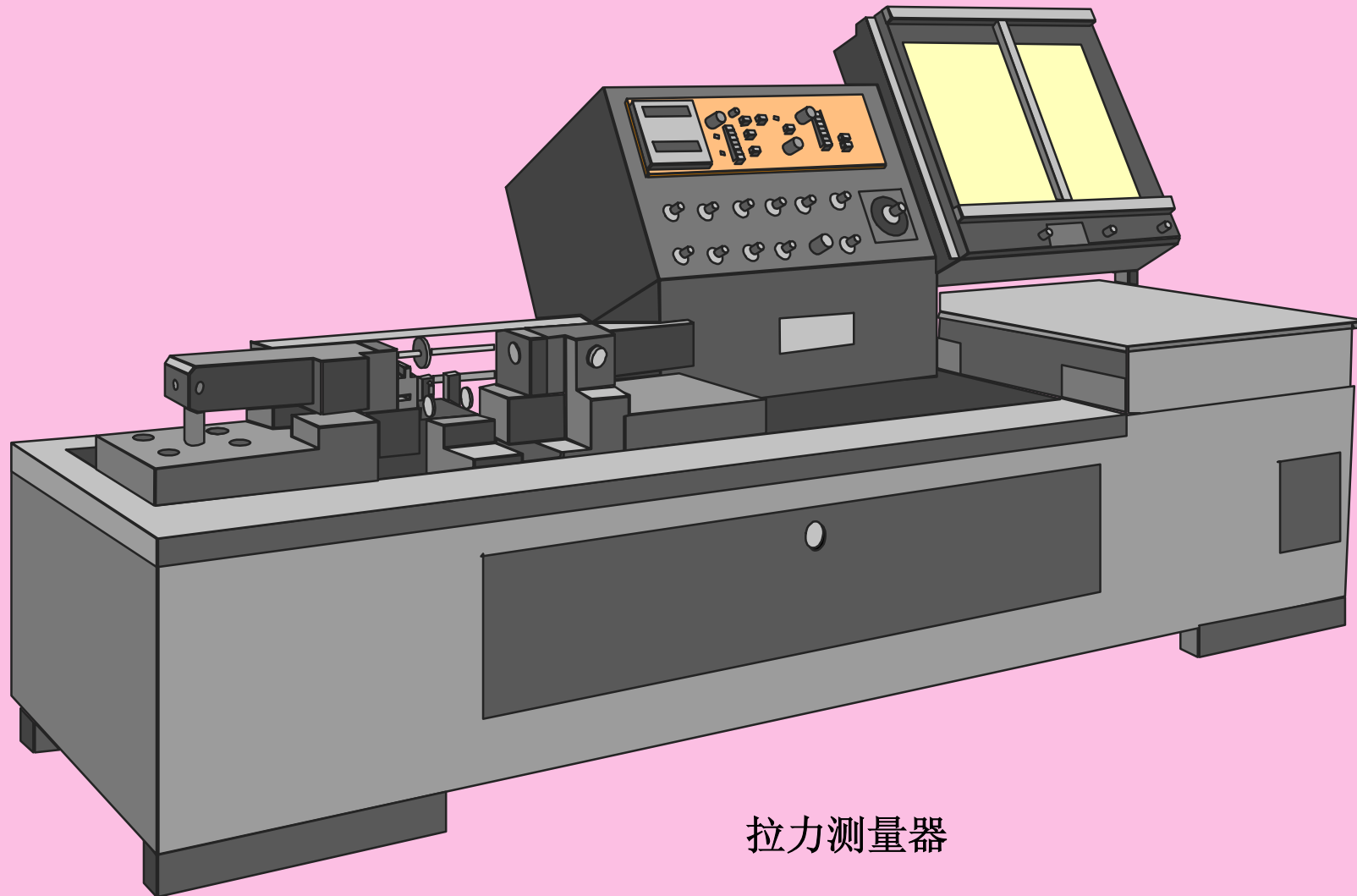

拉力测量器

线芯会合过程

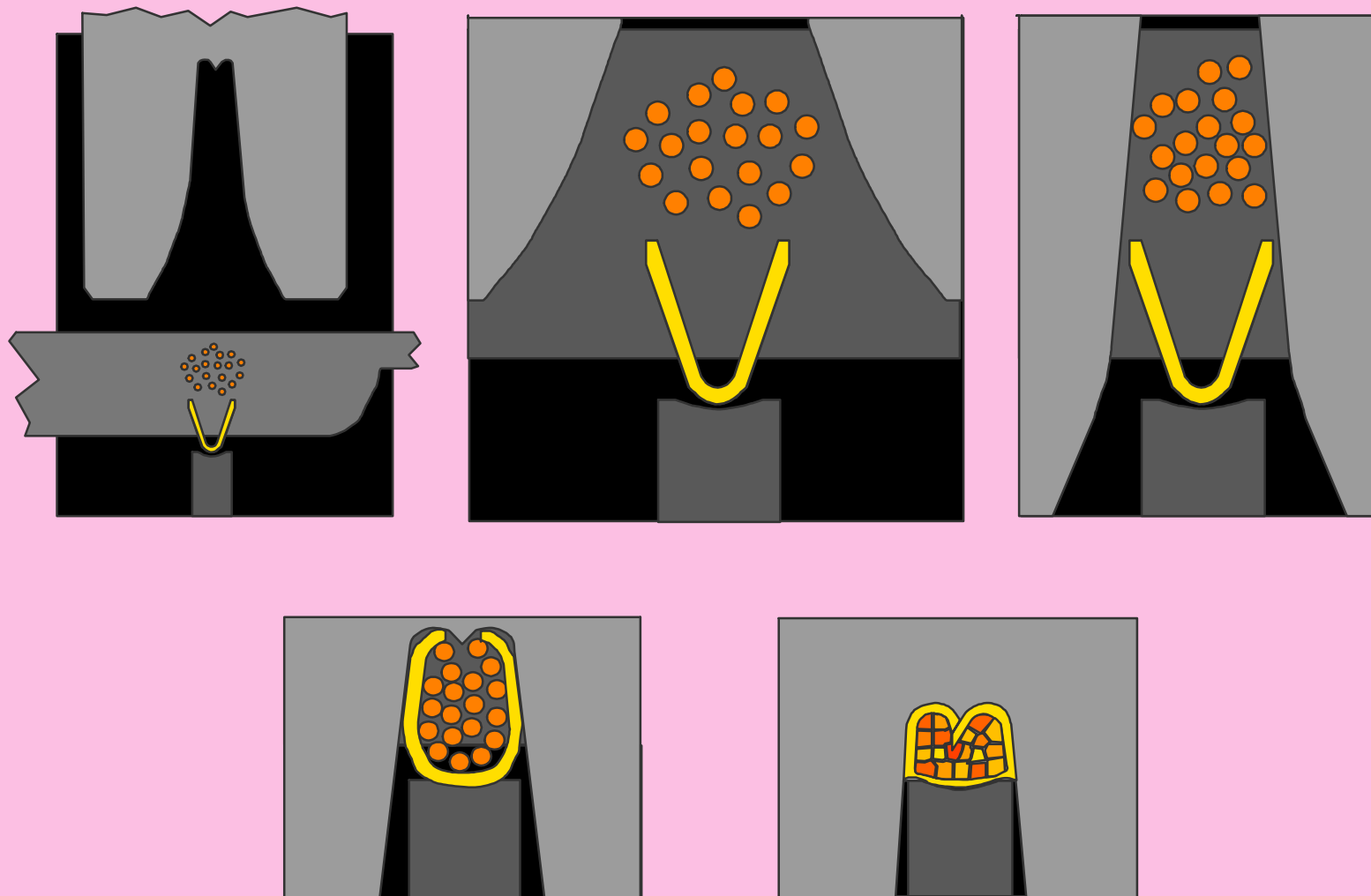

正确的开胶皮长度和放线位置

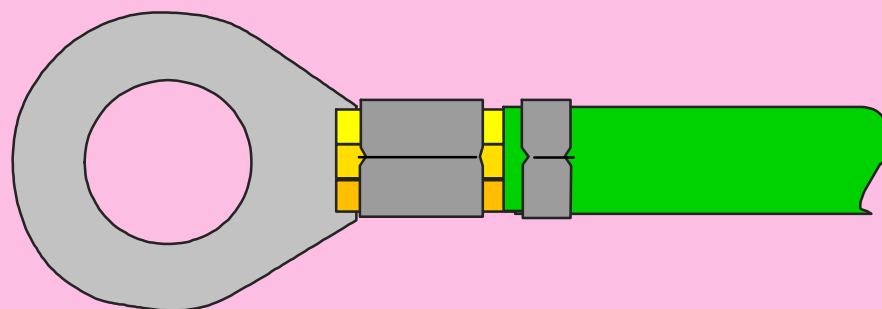
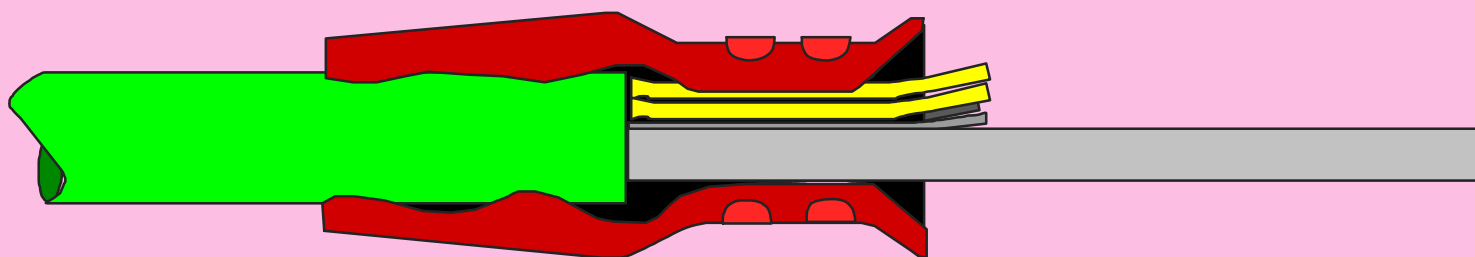

正确的放线位置(后送料)

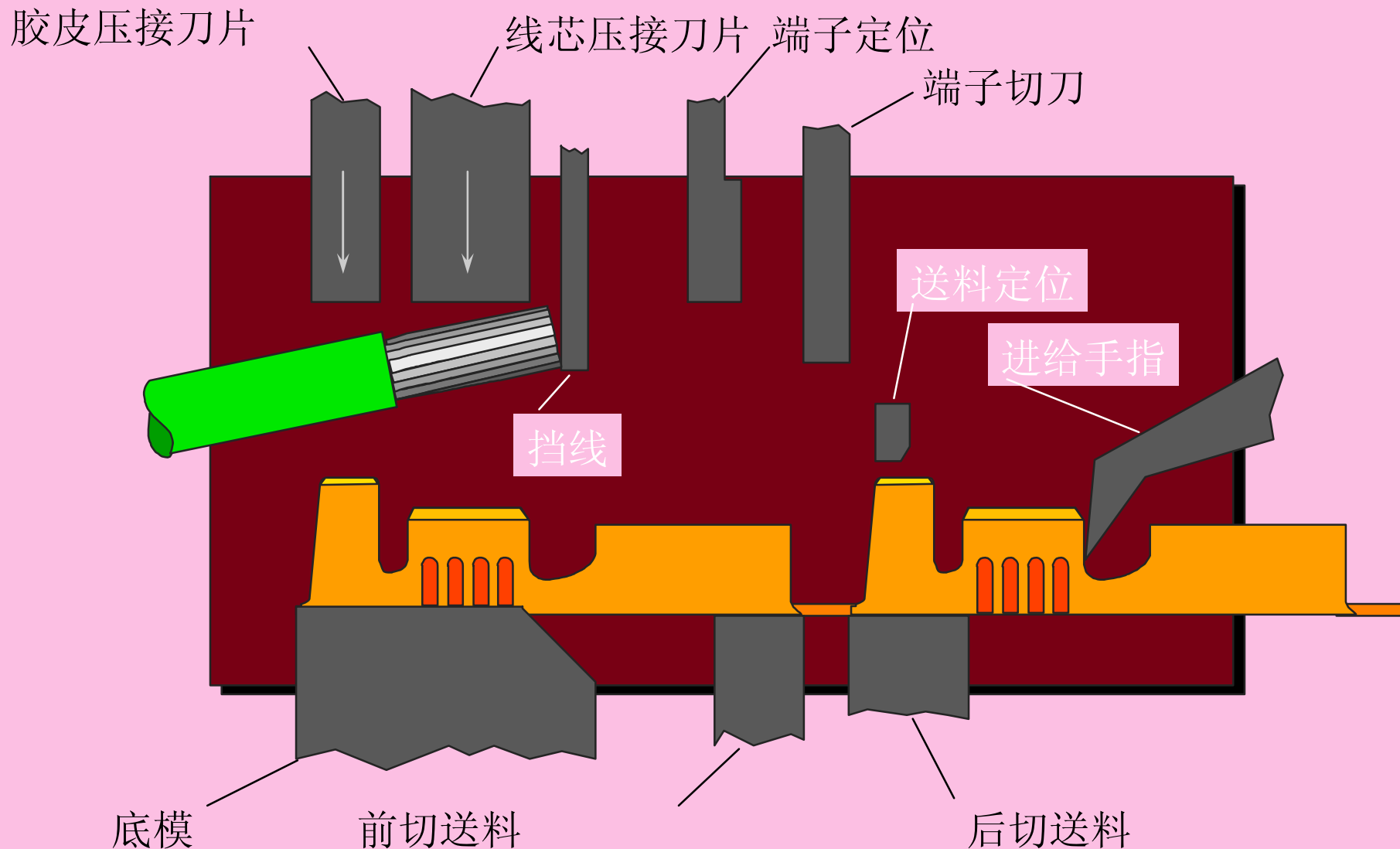

正确的放线位置 (侧送料)

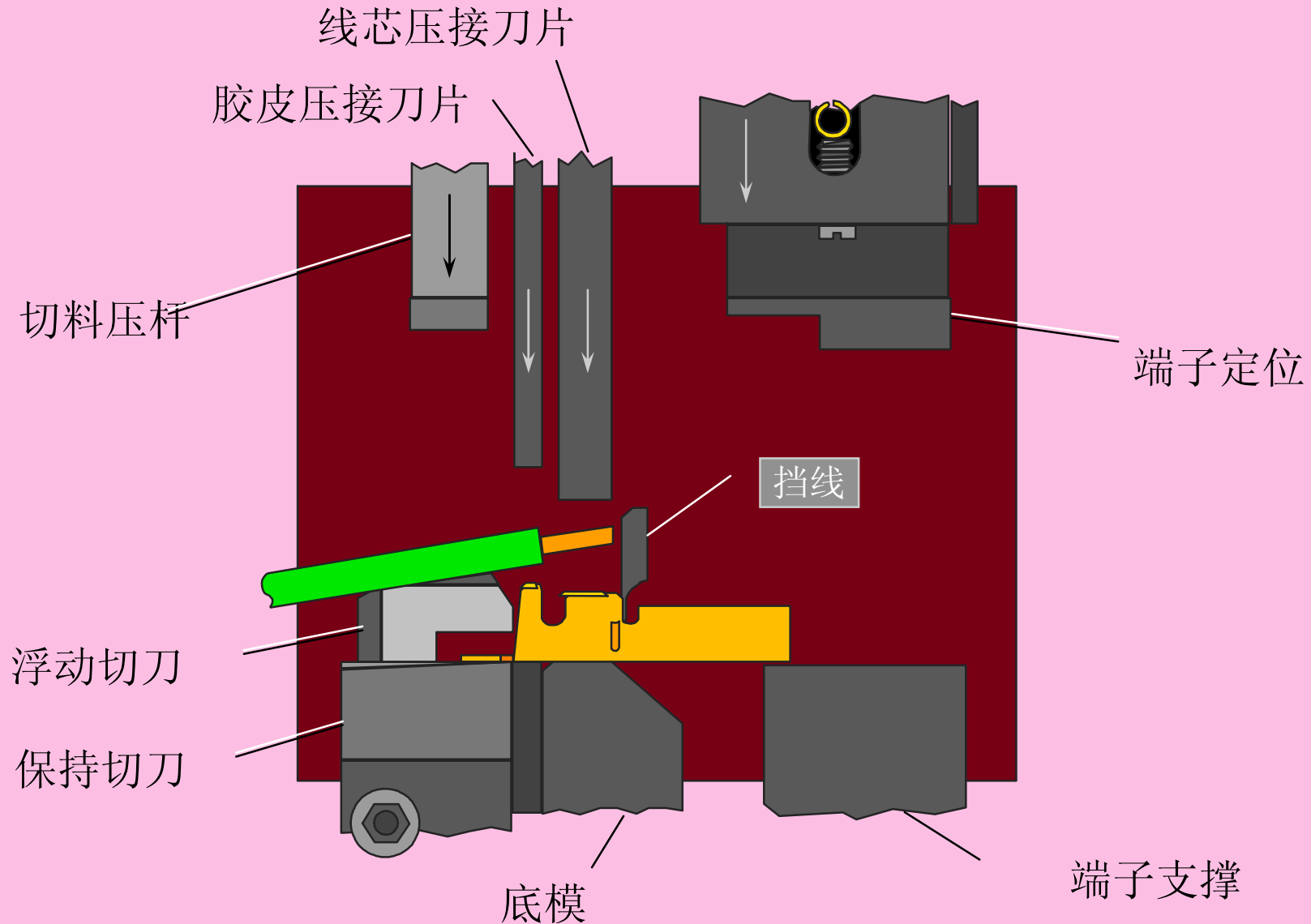

不正确的放线位置

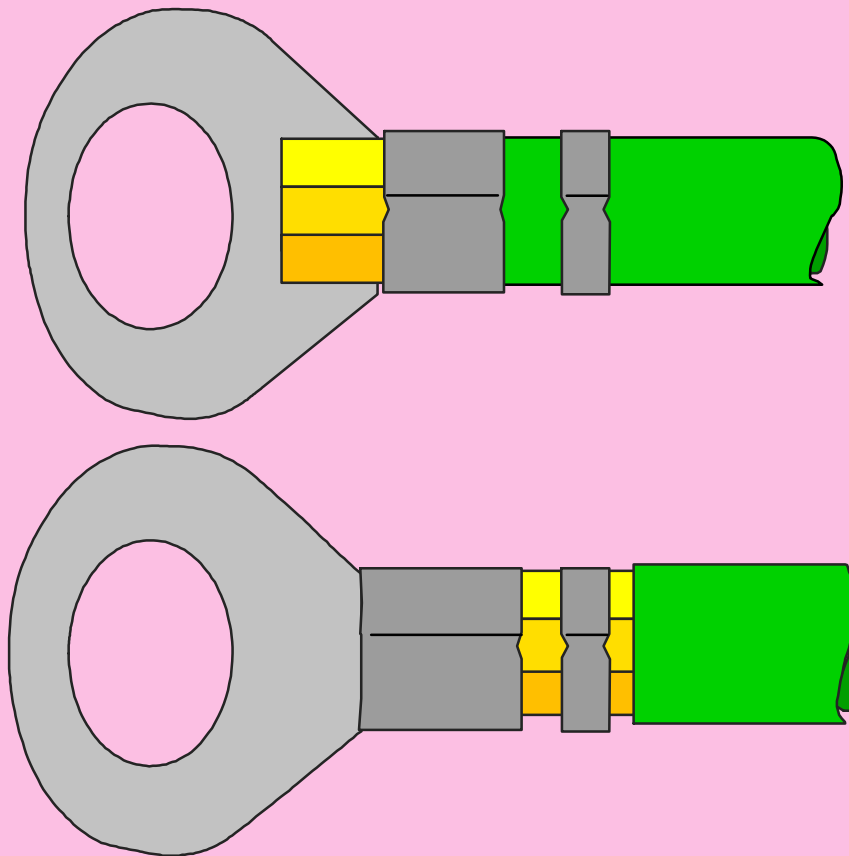

完成压接的端子

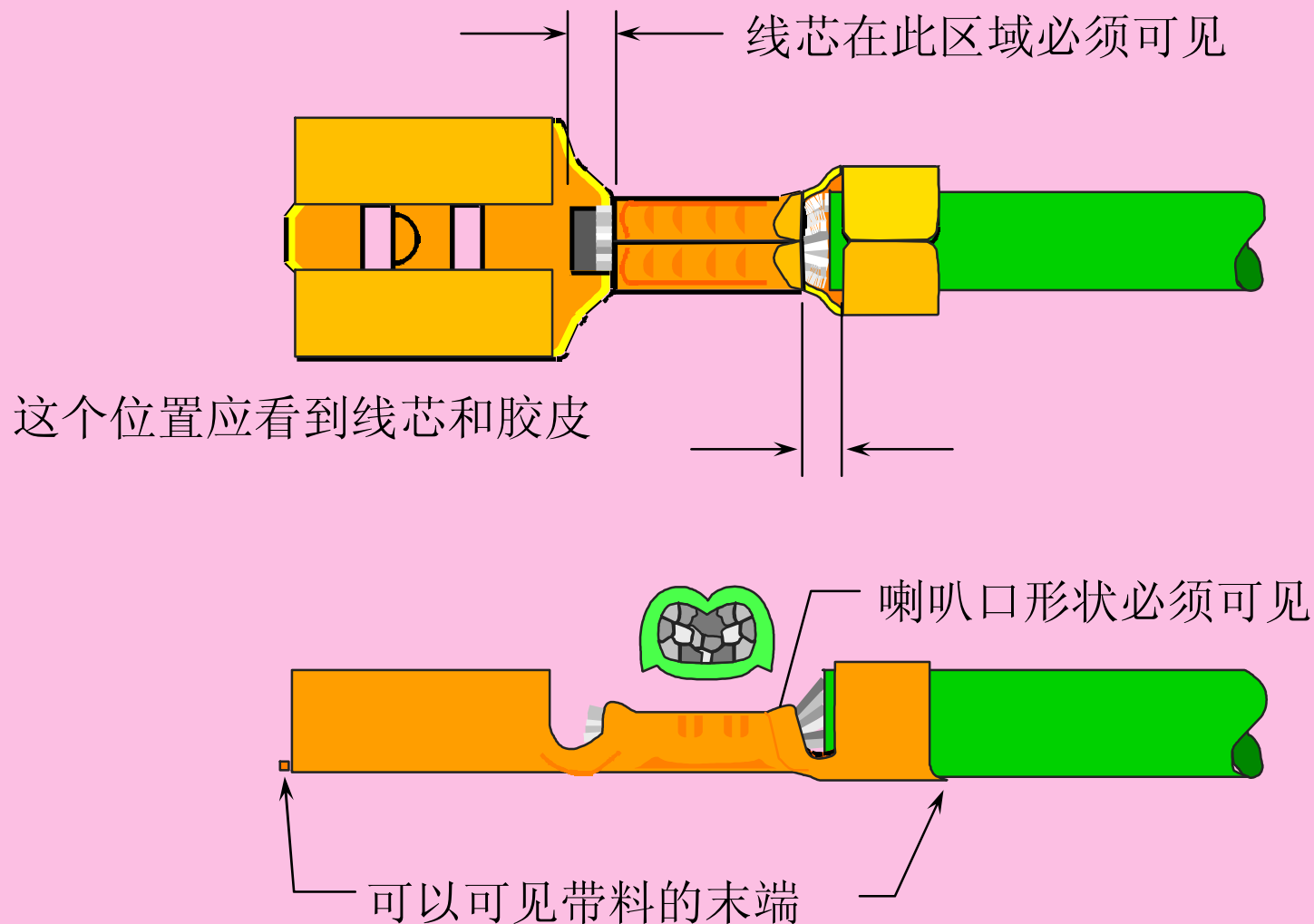

压接完成的端子

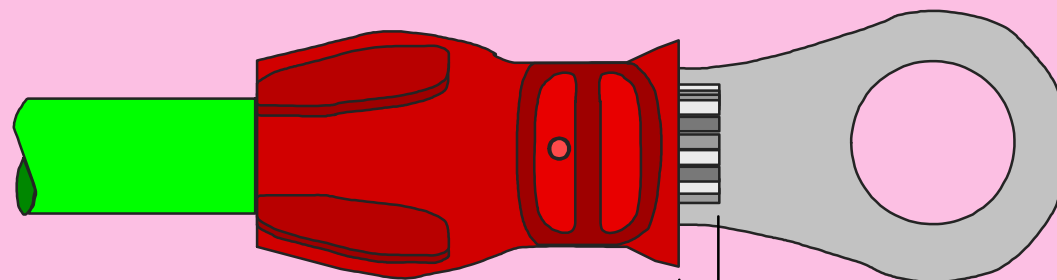

线芯包筒前端
可以看见线芯

胶皮一定要在护套内

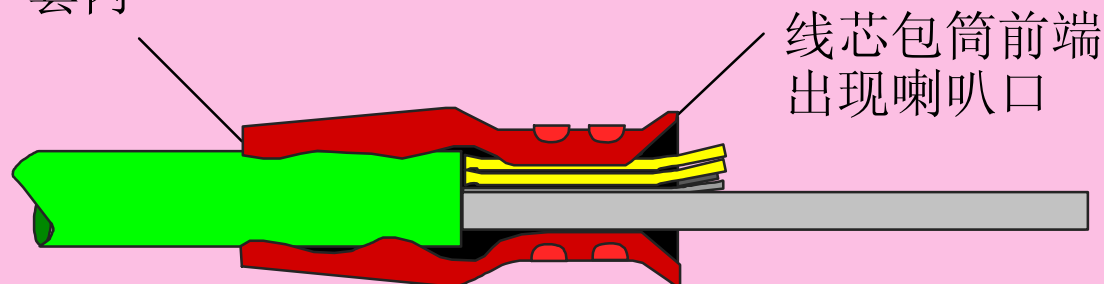

线芯包筒前端
出现喇叭口

组成优质压接的部分

- 电线
- 端子
- 工具
- 文件
- 合格的受训人员

什么是合格的压接？

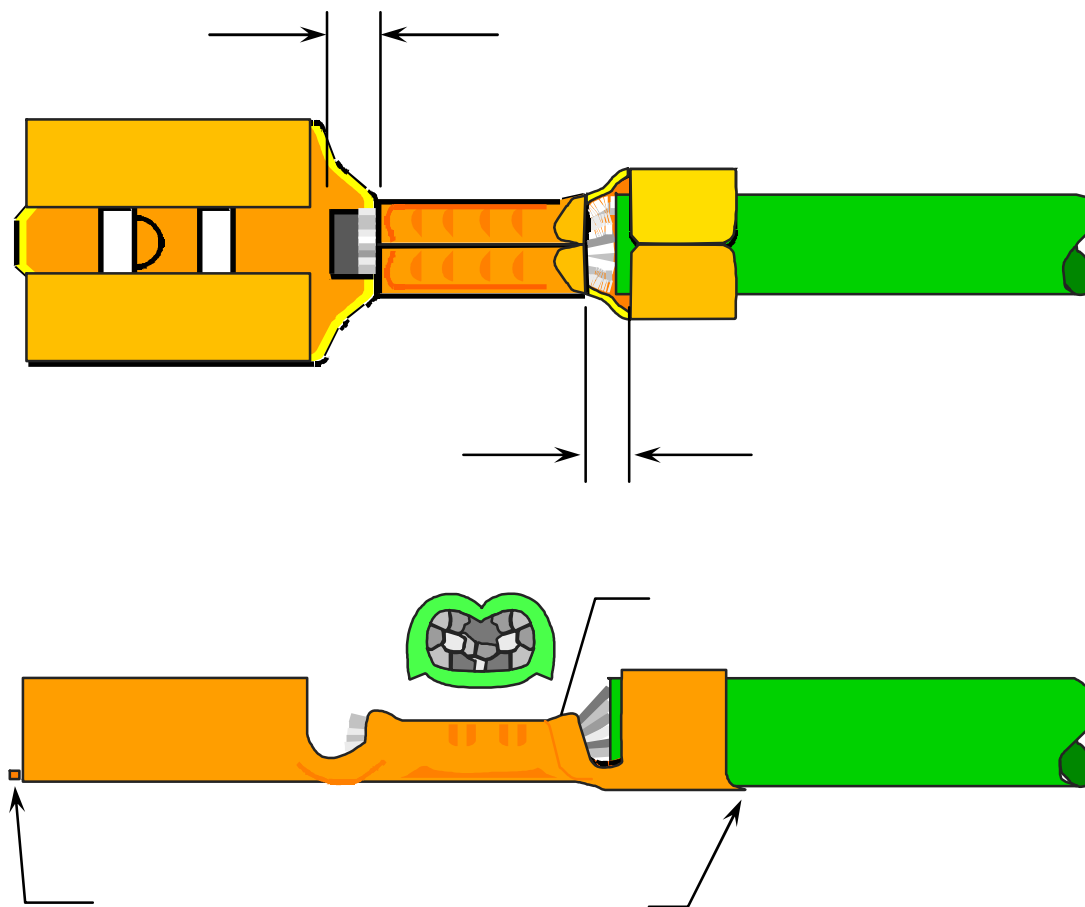

压接完成的端子

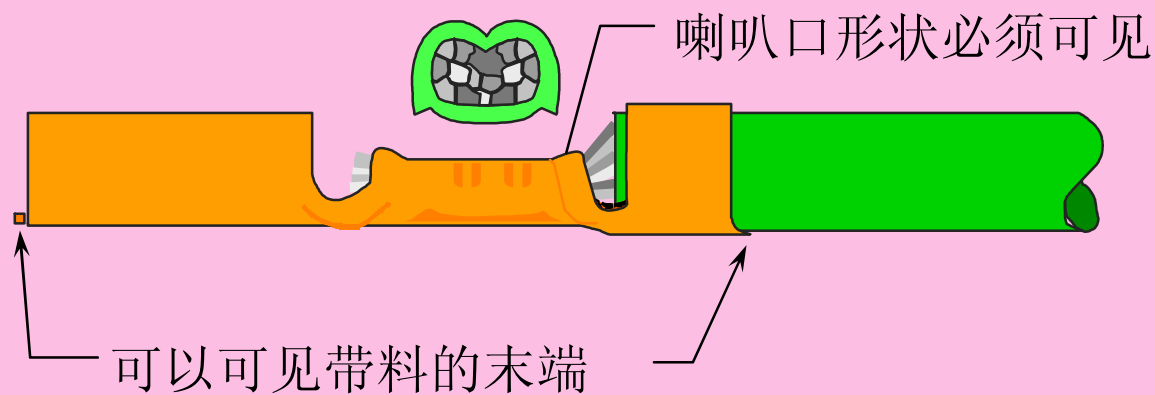
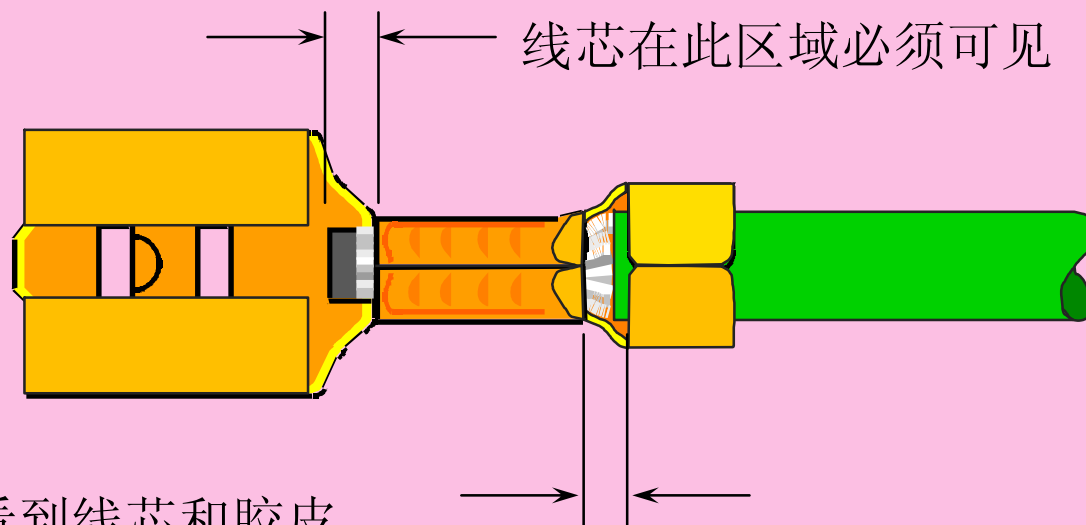

什么是合格的压接？

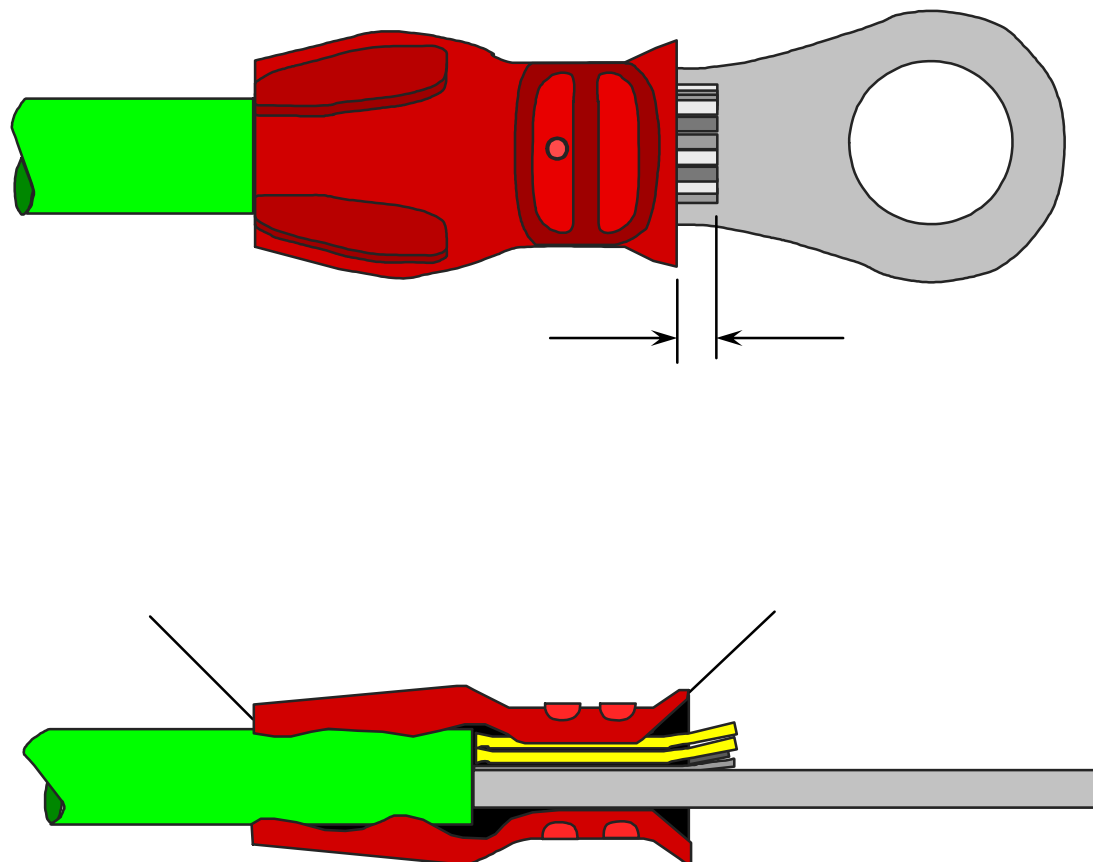

完成压接的端子

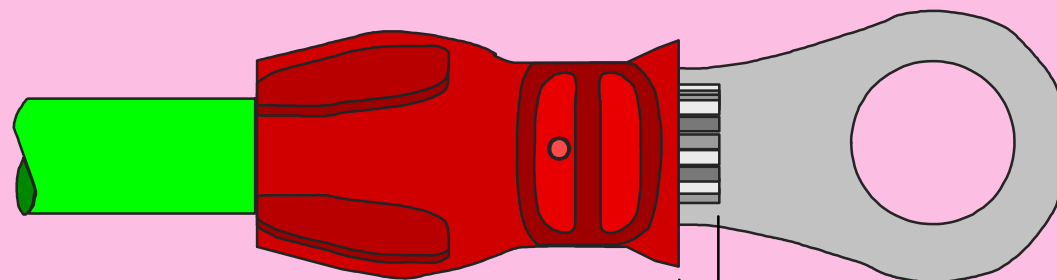

线芯包筒前端
可以看见线芯

胶皮一定要在塑料护套内

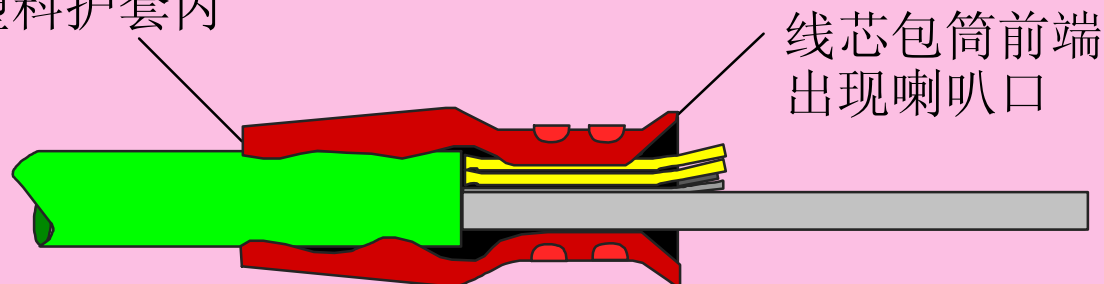

线芯包筒前端
出现喇叭口